

Handle Battery

Tools Required:

- 3 mm Allen wrench
- Small flat head screwdriver
- Battery CR2032

Time:

10 minutes

Remove Handle Battery

NOTICE: Component damage.

Wear an ESD grounding strap during this procedure. Connect ESD grounding strap to frame bolts or unpainted metal of frame. If ESD grounding strap is not available, touch frame bolts or unpainted metal of frame before handling any electronics.

[Video Link](#)

1. Flip handle over to reveal four screws on underside of handle.

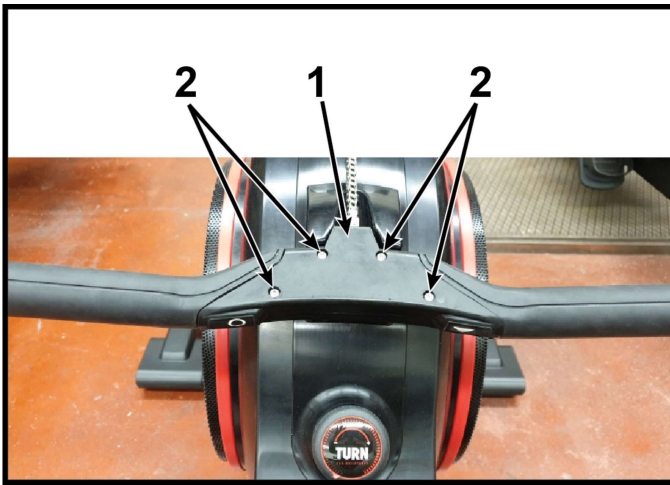

Item	Description	Qty
1	Cover	1
2	Screw	4

2. Remove four screws securing cover using a 3 mm Allen wrench.
3. Remove cover.

4. Remove battery by prying out of bracket with a small flat head screwdriver.



WARNING: Do not pry battery from front of bracket.

Correct

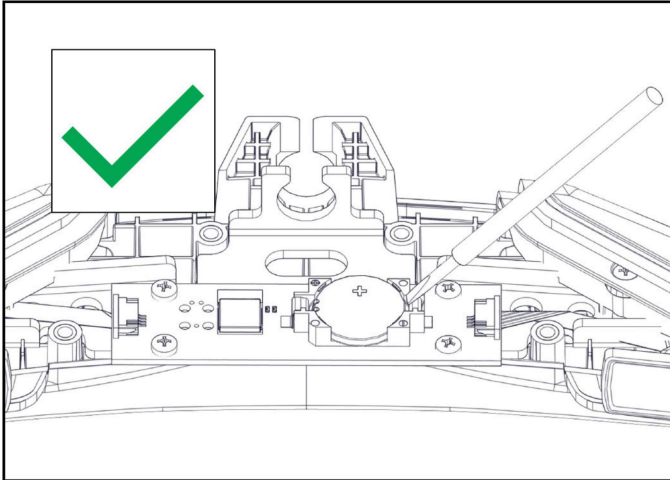

Incorrect

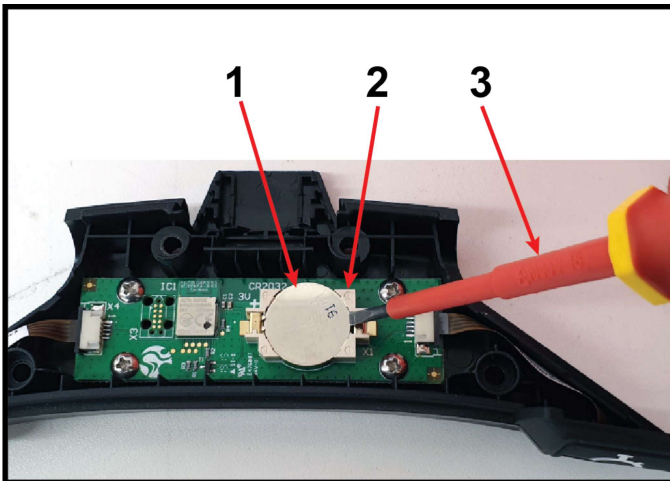
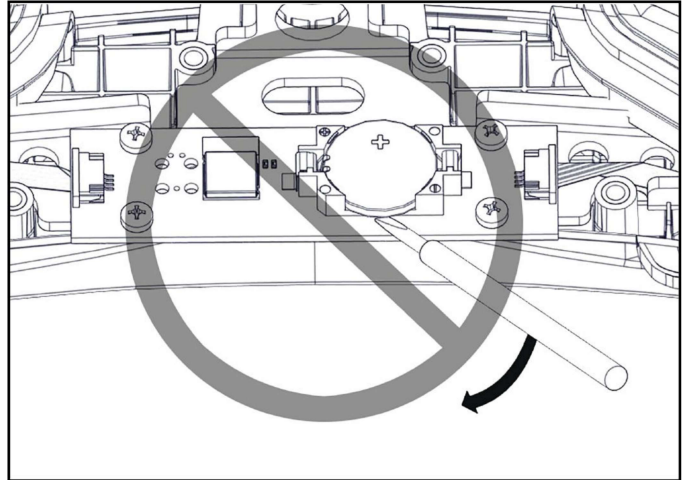

Item	Description	Qty
1	Battery	1
2	Bracket	4
3	Flat head screwdriver	1

Disposing of Batteries

Batteries may not:

- Come into contact with fire.
- Come into contact with coins or other metallic objects.

Products or batteries labeled with this symbol may not be disposed of along with normal household refuse. For proper disposal, please find out about the applicable laws or guidelines on disposing of electrical devices and batteries in your local area and adhere to them.



Install Handle Battery

1. Position battery by placing flat side up (+) and under left prongs.

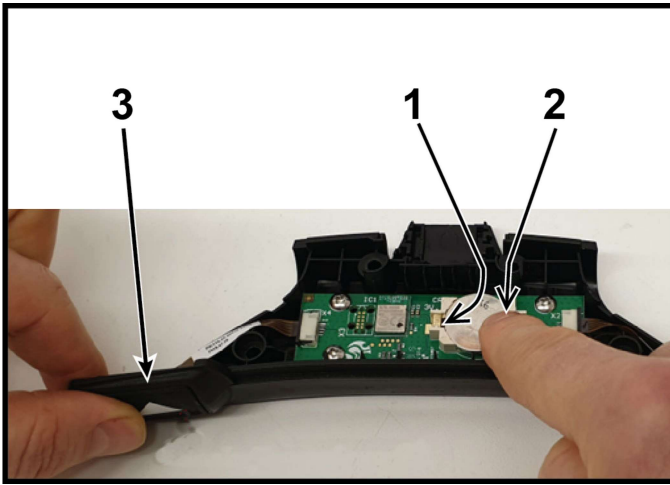

Item	Description	Qty
1	Left prongs	1
2	Push down here	1
3	Handle	1

2. Push down on right side of the battery.
3. Test battery by pressing any button on handle cover. The LED will light up.

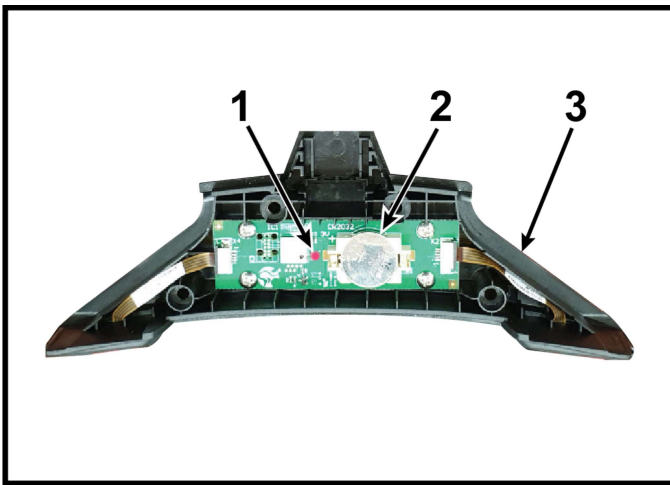

Item	Description	Qty
1	LED	1
2	Battery	1
3	Handle cover	1

If the LED flashes when the button is pressed, replace the battery.

4. Place cover in position on the handle.

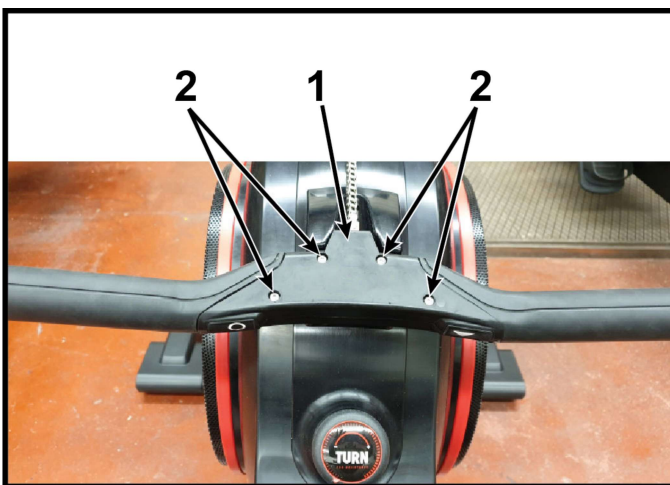

Item	Description	Qty
1	Cover	1
2	Screw	4

5. Install four screws securing cover using a 3 mm Allen wrench.
6. Flip handle over and place in handle retainer.

Handle Pairing

If handle, computer, or handle battery were replaced, the handle and computer must be paired again.

Tools Required: None

Time: 1 minute

[Video Link](#)

1. Navigate to **Mode selection Screen** (start up Screen).
2. Press **Down** and **Split** button until **SETTINGS** menu appears.

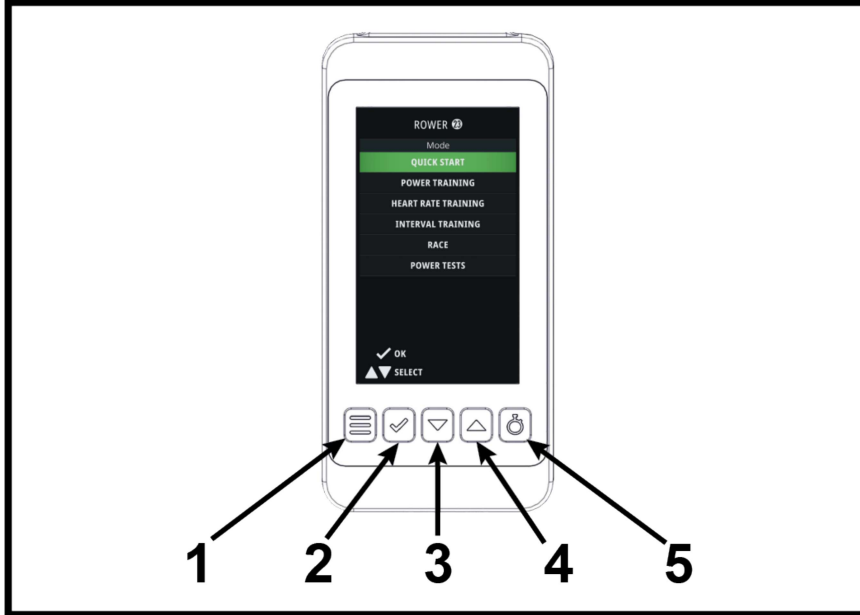

Item	Description	Qty
1	Menu / Back button	1
2	Confirmation button	1
3	Down button	1
4	Up button	1
5	Split button	1

3. Press **Down** button to navigate to **SERVICE** menu, press **Confirmation** button.
4. Navigate to the **HANDLE PAIRING** entry, press **Confirmation** button.

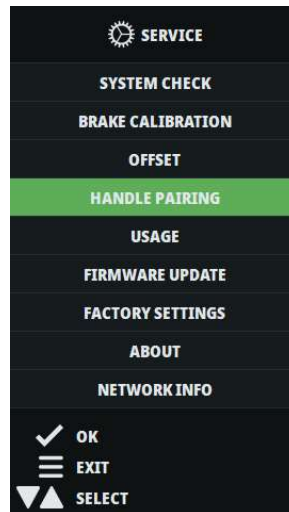

5. Press any button on the handle, wait for pairing to complete.

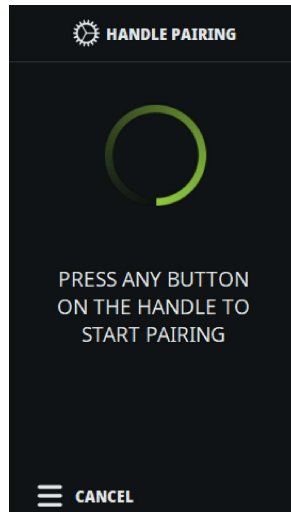

6. When pair is complete, console will display `HANDLE PAIRING SUCCESSFUL`.

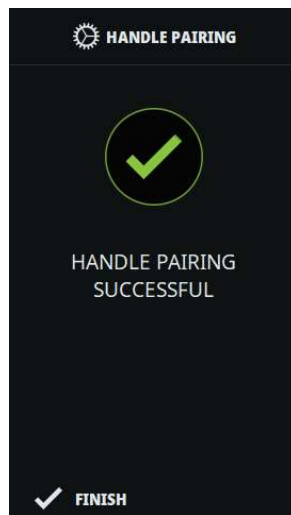

7. Press **Confirmation** button to **FINISH**.
8. Press **Exit**, then **Exit** again to return to **Mode selection Screen** (start up Screen).

If pairing fails, console will display `HANDLE PAIRING FAILED`. Perform the handle pairing procedure again by pressing **Confirm**.

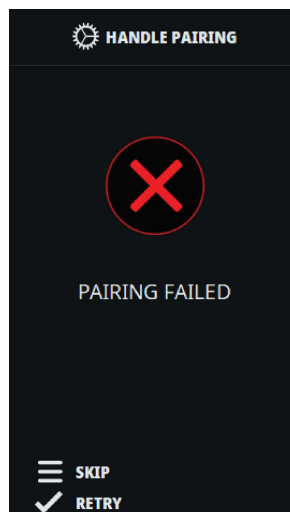

Complete Installation

Operate unit at all levels to verify proper operation.