



Cybex® Eagle Prone Leg Curl

Owner's Manual

Strength Systems

Part Number 11140-999-4 B

Table of Contents

Safety

Safety Guidelines and Practices	3
Anchoring Equipment	3
Facility Safety Precautions	3
User Safety Precautions	4
Warnings and Cautions	6
Label Placement	7

Assembly

Machine Specifications	8
Tools Required	8
Assembly Procedure	8

Exercise

Intended Use	16
Instructions	16

Maintenance

Warnings	18
Daily Procedures	18
Weekly Procedures	20
Yearly Procedures	23
Cable Adjustment	24
Belt Adjustment	25

Customer Service

Product Registration	26
Contacting Service	26
Ordering Parts	26
Return Material Authorization (RMA).	27
Damaged Parts	27

Cybox® and the Cybox logo are registered trademarks of Cybox International, Inc.
Eagle® and its mark are registered trademarks of Cybox International, Inc

DISCLAIMER: Cybox International, Inc., makes no representations or warranties regarding the contents of this manual. We reserve the right to revise this document at any time or to make changes to the product described within it without notice or obligation to notify any person of such revisions or changes.

© Copyright 2012, Cybox International, Inc. All rights reserved. Printed in the United States of America.

10 Trotter Drive Medway, MA 02053 • 508-533-4300 • FAX 508-533-5183 www.cyboxintl.com • 11140-999-4 B August 2012

Safety

Safety Guidelines and Practices

 Read the Owner's Manual carefully before assembling, servicing, or using the equipment. Owner must comply with all safety guidelines in this manual. It is also the owner's responsibility to instruct users on the safe and proper operation of the equipment and to properly display any and all warning labels and instructional placards. All users should read these labels and placards before using equipment.

WARNING

Death or serious injury could occur if the following safety precautions and instructions are not followed.

Anchoring Equipment



- Owner should not allow equipment to be used until it is properly anchored as described below.
- To maximize stability and eliminate rocking, tipping, or falling over, equipment must be anchored to a solid, level surface, utilizing all anchoring holes provided.
- Fasteners must have a minimum of 500 lbs. tensile capacity. Cybox recommends .3/8" grade 2 bolts or better. A minimum pull force of 220 lbs/100 kgs is required for each anchor position.
- If leg frames do not contact surface, **DO NOT** pull down with anchors. Shim any leg or frame not in contact with surface using flat washers.
- Due to the wide variation of flooring on which machines may be anchored or installed, consult with a qualified and licensed contractor to ensure proper anchoring and installation.

Facility Safety Precautions

Do not allow anyone, including trainers, to use equipment in a manner other than that shown on the warning labels and instructional placards located on every machine.

Do not install equipment on an uneven surface. The solid, level surface should not deviate more than 1/8" over a 10' distance or as defined and required by local building and architectural codes.

It is the responsibility of the facility owner/owner of the equipment to ensure that there is appropriate clearance around each machine to allow for safe use and passage.

In compliance with the ADA (American Disabilities Act) there must be clear floor space of at least 30 by 48 inches and be served by an accessible route for at least one of each type of exercise equipment. If the clear space is enclosed on three sides (e.g., by walls or the equipment itself), the clear space must be 36 by 48 inches.

All other machines must have a clear floor space of 23" for all access point on the machine, unless shown in the Owner's Manual.

The dimensions stated in the assembly instructions of this manual include the maximum foot print (in use) dimensions.

All equipment should be used in a supervised, access-controlled area.

Do not allow equipment to be used by children 12 and under. Supervise disabled and children 13 and older.

The owner should ensure that regular inspection and maintenance checks as detailed in this manual are performed. Keep a log of all maintenance and repair activities.

Each day before use, the owner should inspect the equipment. If there are any loose or worn components such as belts, cables, grips, pulleys, or any missing, damaged labels, or placards, the owner should fix any deficiencies before they allow the equipment to be used.

Use only Cybex components to maintain and repair the equipment.

Display the Facility Safety Sign so it is visible and prominent.

User Safety Precautions

Owners must instruct users to **DO** the following:

- Follow all warning labels and instructional placards when using equipment.
- Insert weight pin completely before using selectorized equipment.
- Consult a physician prior to commencing an exercise program. If at any time during exercise you feel faint, dizzy or experience pain, stop and consult your physician.
- Use a spotter for Free Weight equipment.

Owners must instruct users to **NOT DO** the following:

- **DO NOT** pin weights on selectorized equipment in an elevated position or use the machine if found in this position.
- **DO NOT** increase weight resistance on equipment by any means other than those provided by Cybex.
- **DO NOT** wear loose or dangling clothing or jewelry while using equipment. Stay clear of moving parts.

- **DO NOT** lean or pull on machine
- **DO NOT** use machine for support during stretching.
- **DO NOT** attach resistance straps, ropes or other means to equipment, except those provided by the manufacturer for intended use on the equipment.
- **DO NOT** exceed the maximum specified user weight.
- **DO NOT** use if equipment appears damaged or inoperable upon inspection.
- **DO NOT** use if guards are missing or damaged.
- **DO NOT** remove any labeling from equipment.

Warnings and Cautions

Warning decals indicate a potentially hazardous situation that could result in death or serious injury if the precautions are not observed.

Caution decals indicate a potentially hazardous situation, which, if not avoided, could result in minor or moderate injury.

The diagram following the decals show where each decal is located.

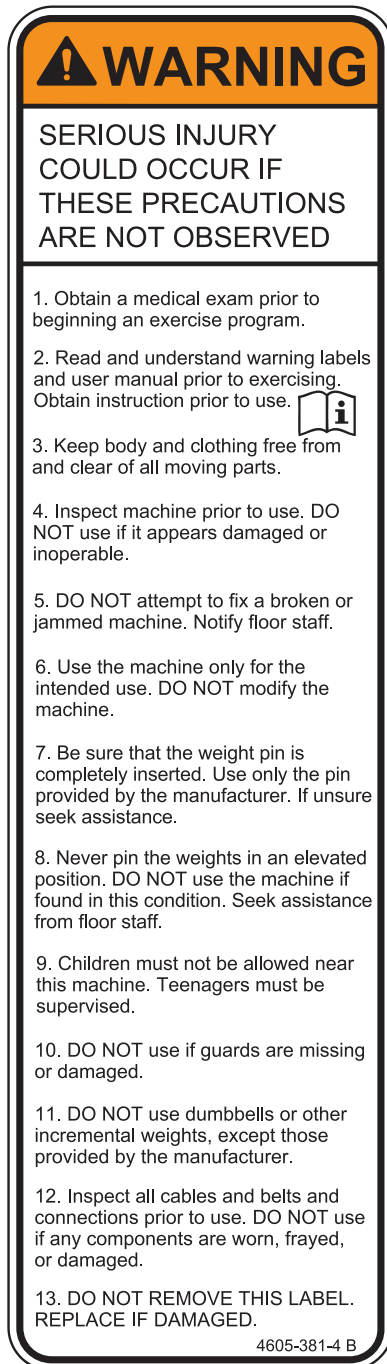

Label Placement

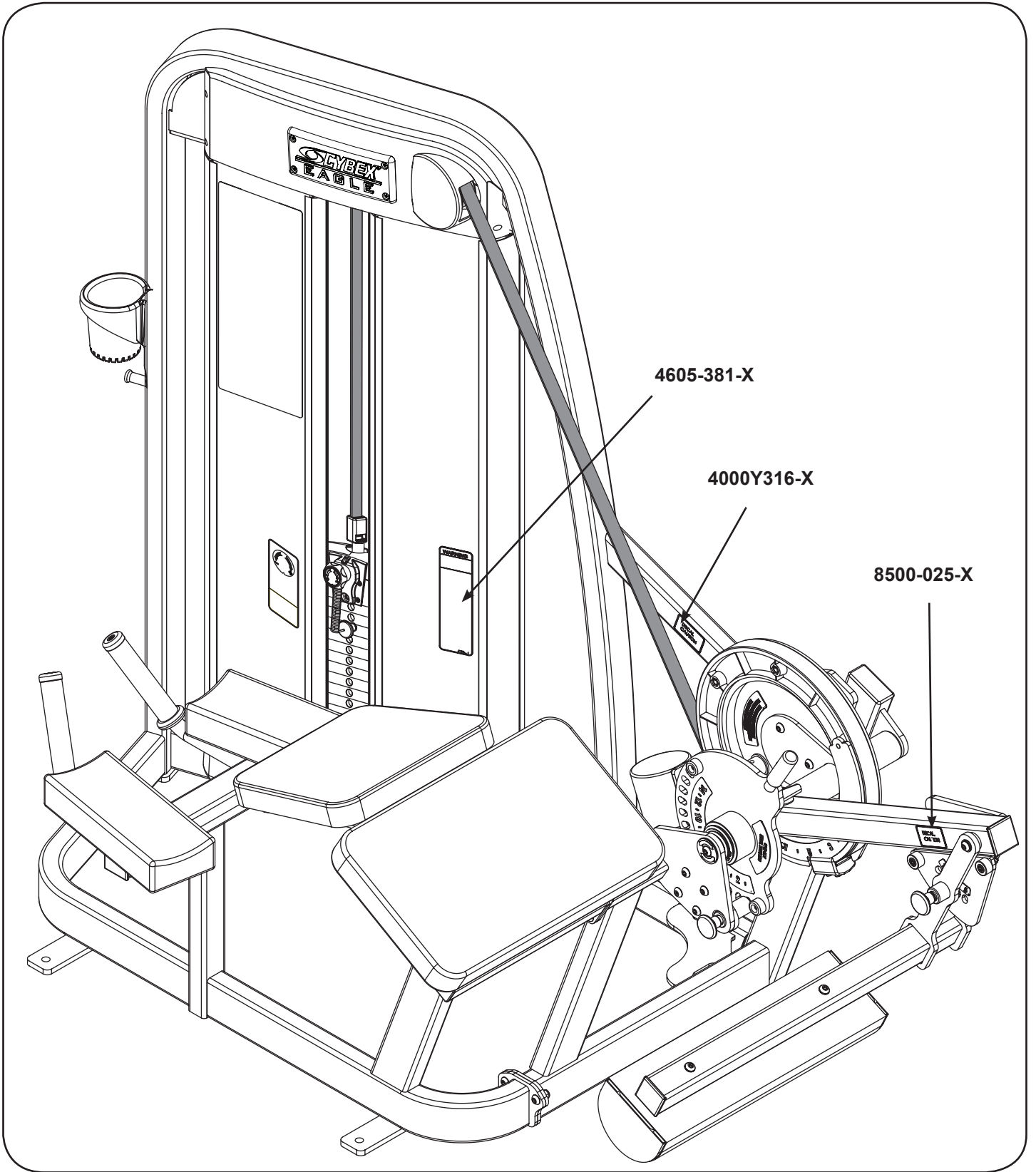

Assembly

Machine Specifications

Total Weight and Size: Eagle 11140 Prone Leg Curl

Weight	Machine Dimensions at Rest	Machine Dimensions at Use
500 lbs	41" W x 78.5" L x 58" H	41" W x 78.78" L x 58" H
226.79 kg	104.14 cm W x 199.39 cm L x 147.32 H	104.14 cm W x 200.10 cm L x 147.32 H

The dimensions stated in the installation instructions are the recommended minimum dimensions as set forth by the manufacturer. The actual area for access and passage shall be the responsibility of the facility and should take into account any required local codes or regulations.

Tools Required

- 7/32" Allen wrench
- 3/4" Allen wrench
- 9/16" Wrench
- External snap ring pliers
- Phillips screwdriver
- Medium weight automotive engine oil
- Torque Wrench

Assembly Procedure

Two people will be required for this procedure.

 Read and understand all instructions thoroughly before assembling this unit. Check all items carefully. If there is damage, see the Customer Service section of this manual for proper procedure to return, replace, or reorder parts.

It is the responsibility of the facility owner/owner of the equipment to ensure that there is appropriate clearance around each machine to allow for safe use and passage.

Verify parts list shown below

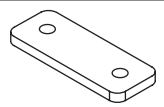
Qty	Part Number	Description	Diagram
5	11090-392	Foot pad	

Qty	Part Number	Description	Diagram
1	12000-560	Decal, Weight Plate (30-290)	

6. Attach each half together using the nine BHSCS that were removed.

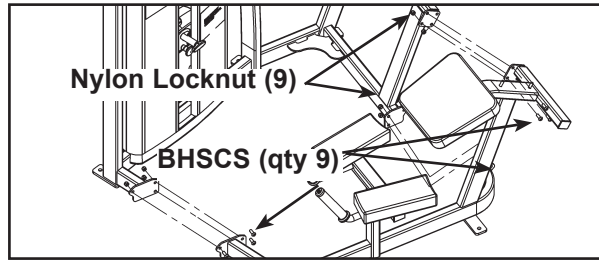

Install rubber feet

1. Remove each (standard) cone-shaped shipping support using a 3/4" socket or wrench.
2. Cut shipping tie securing top weight.
3. Place rubber feet (supplied with machine) on each foot of the frame.
4. Lift top weight and turn the Increment Weight Adjusting Knob to select 15 lbs (three increment weights each side.)
5. Remove the three Phillips head screws securing the top (back) shroud and carefully remove the shroud.

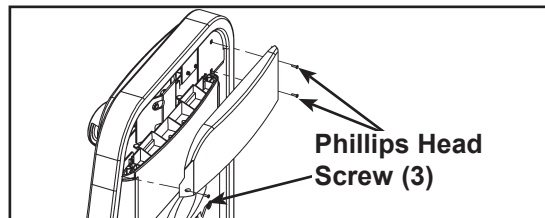

6. Loosen but do not remove bottom two screws.

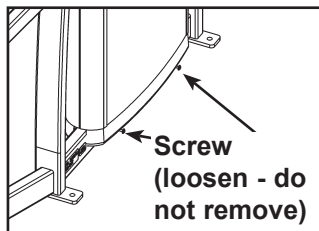

7. Remove the top two screws securing the back shroud.

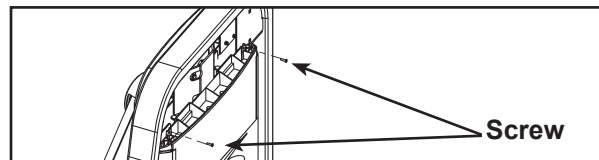

8. Slide rear shroud assembly upward and remove.

Install the weight stack

1. Note how the increment weights are installed.
2. With an assistant holding the increment weights, move the adjusting knob to 0 lbs and remove all six increment weights (three each side.)
3. Using an external snap ring pliers, remove the upper snap ring from one of the guide rods and carefully lower the guide rod.

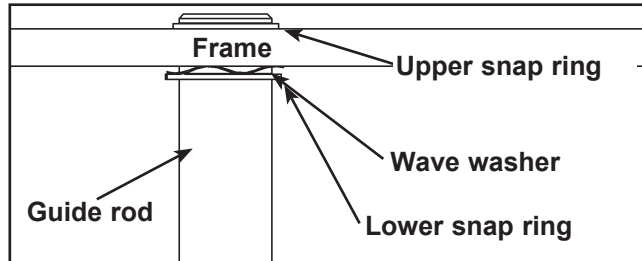

4. Remove lower snap ring and wave washer from the guide rod. Repeat for the opposite guide rod.
5. Lean guide rods outward, away from machine in order to provide the most room for installing weight plates.
6. Slide top weight up and out of machine and carefully set it aside.
7. Wipe guide rods clean over entire length. Lubricate with light coating of medium weight automotive engine oil.
8. Install each weight plate one at a time. When installing weight plates, position plates so wide edges of bushing face upward and narrow edges of bushing face downward.

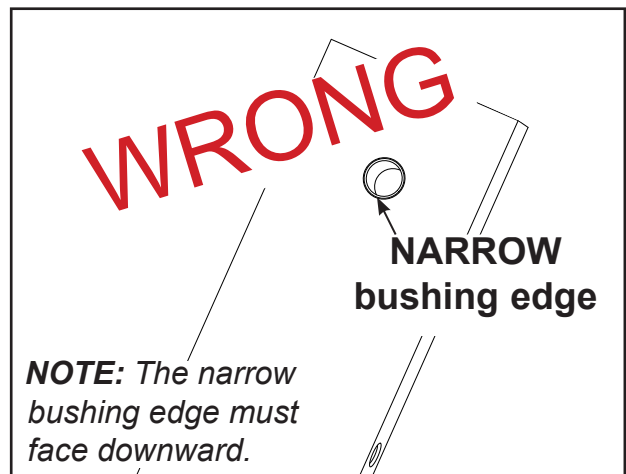
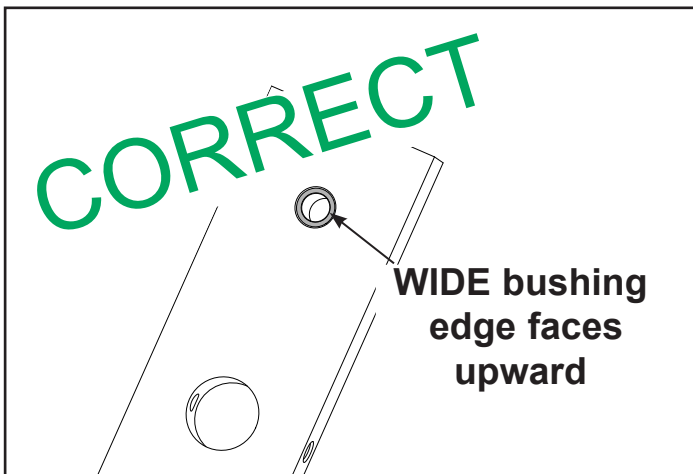

- Slide top weight onto guide rods.
- Place lower snap ring and wave washer onto guide rod (about 3" from the top end of guide rod.)
- Raise guide rod up through mounting hole and install the upper snap ring.
- Lower guide rod and secure lower snap ring. Repeat for the opposite guide rod.

Belt Routing

- Verify belt is routed through top of pulley bracket and then route end of belt down to the top weight.
- Verify that the position of the belt clamp (on the top weight) is aligned properly with the top pulley bracket (on the machine.) The belt must have a straight path from the pulley to the belt clamp. Figure shows the top view, looking from the top pulley down to the top plate.

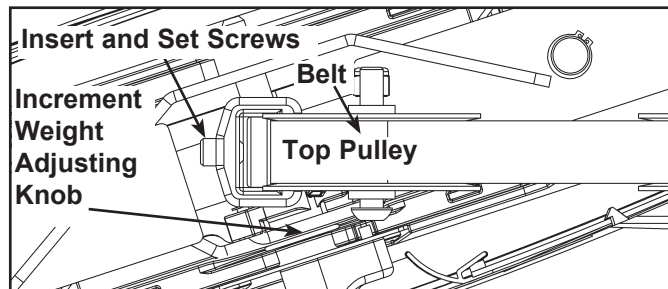

- Slide belt through slot in belt clamp.
- Verify belt and insert are installed properly.

Correct belt routing

Wrong belt routing

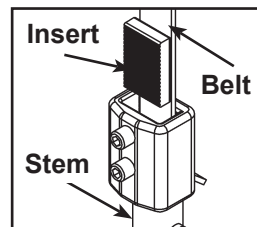
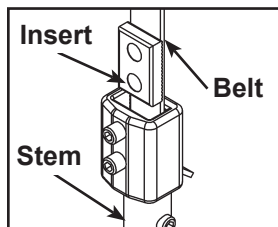

- Pull belt tight and secure belt to clamp with the two set screws. Torque set screws 300-350 in-lbs.

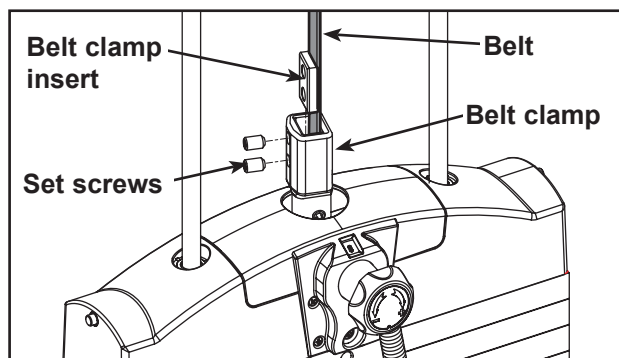

6. Place weight stack pin in each plate to verify proper installation.
7. Without selecting any resistance, lift top weight up and down (simulating normal operation.)
8. Verify that the belt is moving smoothly and is routed straight from the top pulley bracket to the weight belt clamp.
9. Reinstall the six increment weights that were removed.

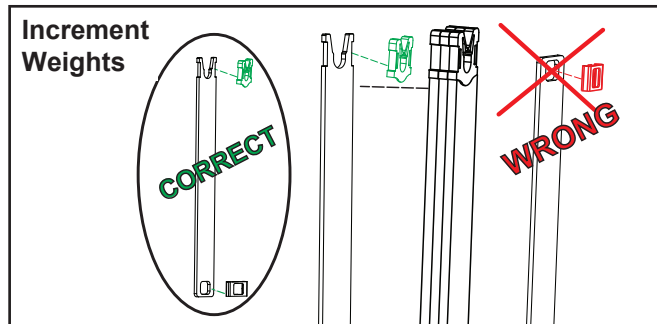

10. Turn the Increment Weight Adjusting Knob to select 15 lbs.

Install back shrouds

1. Place shroud back into position on the two bottom screws.

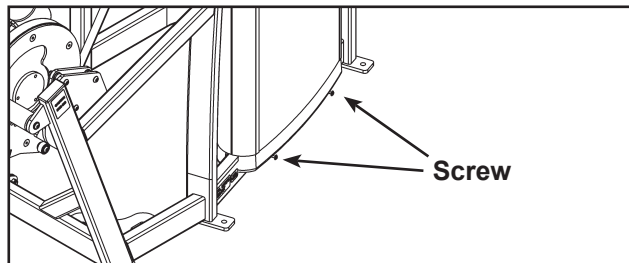

2. Install the top two screws securing the back shroud.

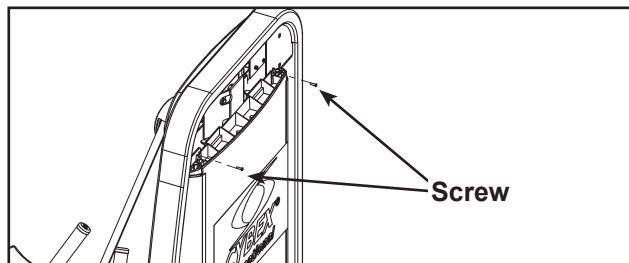

3. Install the three Phillips head screws securing the top (back) shroud.

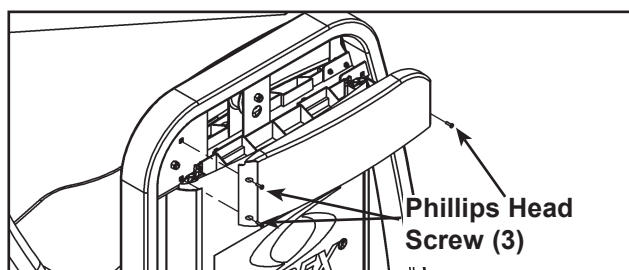

Install weight plate decals

You have the option to use pounds, kilograms or both.

1. Slowly and carefully peel off back side of decal, making sure that the decals remain attached to the front sticker.

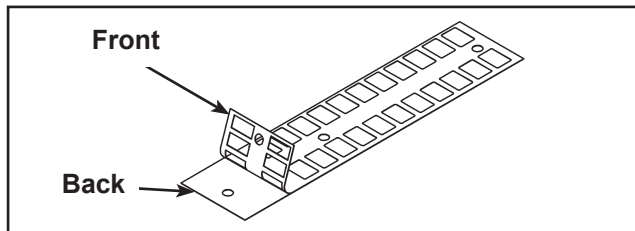

2. Align holes in decal with appropriate holes in weight stack. Do not allow the adhesive to touch weight stack at this time.
3. Insert a guide pin through each hole of the template. A guide pin can be anything that fits through the weight stack hole, such as a weight stack selector pin.
4. Align decal and rub it onto weight plates.
5. Remove front side, leaving decals adhering to weight plates.

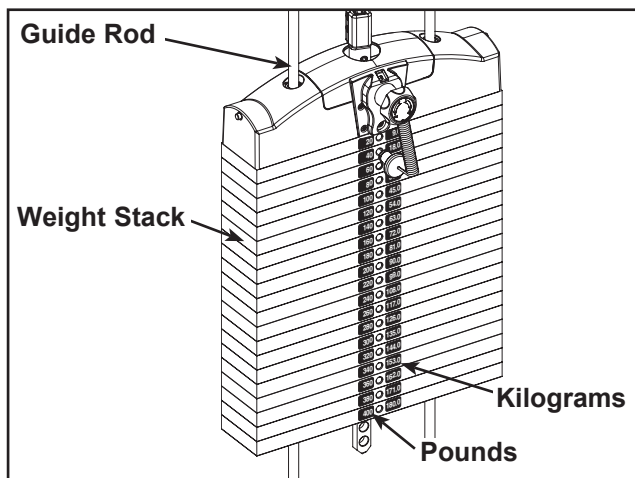

IMPORTANT:

It is important that you perform regular inspection and maintenance activities on your equipment. See the CYBEX Eagle Owner's Manual for inspection and maintenance activities. If you do not have a CYBEX Eagle Owner's Manual or if you have any questions or concerns, call CYBEX Customer Relations at 888-462-9239.

Securely anchor machine to the floor

Cybox strongly recommends to maximize stability, equipment must be secured to a solid level surface.

 **CAUTION:** *Cybox is not responsible for the actual anchoring of equipment. Consult with a professional contractor.*

 **WARNING:** *Use fasteners having a minimum of 500 lbs. tensile capacity (3/8" grade 2 bolts or better).*

 **WARNING:** *If legs/frame does not contact surface, DO NOT pull down with anchors. Shim any leg or frame not in contact with surface using flat washers.*

Verify proper operation

Exercise

Intended Use

The intended commercial use of this machine is to aid exercise and improve general physical fitness.

Instructions

 Read and understand all instructions and warnings prior to using this machine in the Safety section of the Owner's Manual.

All adjustment points on the machine have yellow handles or knobs.

Set Up

1. Adjust leg pad for a comfortable placement behind ankles.
2. Align knee with axis of rotation.



Movement

1. Pull up against leg pad.



CAUTION: *Serious injury can result if precautions are not followed. Use equipment only as described in placards located on each machine. Failure to use in the manner depicted can result in injury.*

PRONE LEG CURL

START

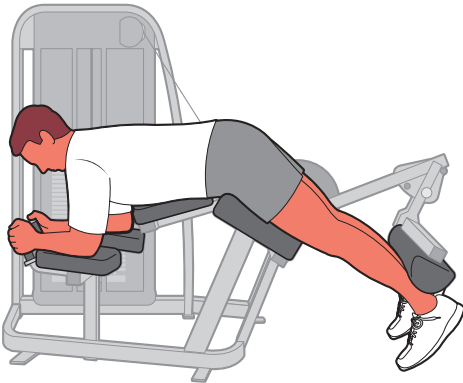

FINISH

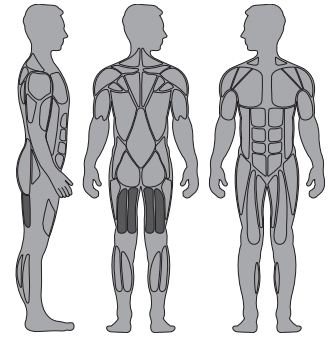
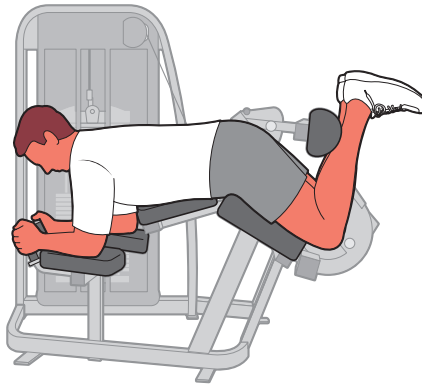

Motions Developed
Knee Flexion
Muscles Used
Hamstrings

Maintenance

All preventive maintenance activities must be performed on a regular basis. Performing routine preventive maintenance actions can aid in providing safe, trouble-free operation of all Cybex equipment.

Cybex is not responsible for performing regular inspection and maintenance actions for your machines. Instruct all personnel in equipment inspection and maintenance actions and also in accident reporting/recording. Cybex representatives are available to answer any questions that you may have.

Warnings

 Read all warnings in this chapter.



WARNING: *For maintenance, service and repair:*

- *Must be performed by trained service personnel only*
- *Use only Cybex replacement parts.*

Observe the following warnings:



WARNING: *Equipment hazard.*

To avoid serious injury or death replace worn or damaged components immediately and keep the equipment out of use until repair is completed.

Daily Procedures

When using strong cleaning agents such as rubbing alcohol or bleach, it is advisable to first test in an inconspicuous area. Other cleaning agents may contain harsh or unknown solvents and are subject to formula changes by the product manufacturer without notice. Should you desire to use other cleaning agents, carefully try them in an inconspicuous area to determine potential damage to the material. Never use harsh solvents or cleaners which are intended for industrial applications. To clean stained or soiled areas, a soft white cloth is recommended. Avoid use of paper towels.

Cleaning products may be harmful/irritating to your skin, eyes, etc. Use protective gloves and eye protection. **Do Not** inhale or swallow any cleaning product. Protect surrounding area/clothing from exposure. Use in well ventilated area. Follow all product manufacturer's warnings. Cybex and its vendors cannot be held responsible for damage or injuries resulting from the use or misuse of cleaning products.

Clean Upholstery

If	Then
Light Soiling	<ol style="list-style-type: none"> 1. Prepare a solution of 10% household liquid soap and warm water. 2. Apply with a soft damp cloth. 3. If necessary, apply a solution of liquid cleanser with a soft bristle brush. 4. Dampen a clean soft cloth in water and wipe residue away.
More Difficult Stains	<ol style="list-style-type: none"> 1. Prepare a solution of 10% household bleach (sodium hypochlorite) and 90% water. Dampen a soft white cloth in the solution. 2. Rub gently on the stained area. 3. Dampen a clean soft cloth in water and rinse area. 4. If stains are still present, a full strength household bleach may be used. Allow bleach to puddle on the affected area or apply with a bleached-soaked cloth for approximately 30 minutes. Dampen a clean soft cloth in water, and rinse area to remove any remaining bleach concentration.
More Difficult Stains (Alternative Method)	<ol style="list-style-type: none"> 1. Dampen a soft white cloth with rubbing alcohol. 2. Gently rub stained area. 3. Dampen a clean soft cloth in water and rinse area.
Restoring Luster	<ol style="list-style-type: none"> 1. Apply a light coat of furniture wax for 30 seconds. 2. Lightly rub area using a clean white cloth.

Clean Frames

Wipe down all frames using a mild solution of warm water and car wash soap. Be sure to dry thoroughly. **AVOID** acid or chlorine based cleaners and also cleaners containing abrasives as these could scratch or damage the equipment.

Clean Chrome

Clean chrome tubes, first using chrome polish and then using a car wax seal. Neutral cleaners with a pH between 5.5 and 8.5 are recommended. Be sure to dry thoroughly. **AVOID** acid or chlorine based cleaners and also cleaners containing abrasives as these could scratch or damage the equipment.

Guidelines for cleaning front panel:

Use clean soft cloths or sponges for application of cleaners and again for washing and rinsing. Follow up each application with warm water rinse.

- **DO NOT** use abrasives or high alkaline cleaners.
- **DO NOT** leave cleaners on for long periods, wash immediately.
- **DO NOT** apply cleaners in direct sunlight or at elevated temperatures.
- **DO NOT** use scrapers, squeegees, or razors.
- **DO NOT** clean with gasoline.

Compatible Cleaners and Detergents:

- Formula 409
- Top Job
- Joy
- Palmolive
- Windex with Ammonia D

To Minimize Fine or Hairline Scratches:

Mild automotive polish applied and removed with a soft clean cloth will help fill scratches.

Suggested Polishes:

- Johnson Paste Wax
- Mirror Glaze #10 Plastic Polish (by Mirror Bright Polish Co.)
- Novus Plastics Polish #1, #2 (By Novus Inc.)

Weekly Procedures

Inspect All Nuts and Bolts

Tighten all loose nuts and bolts as required.



WARNING: Equipment hazard.

To avoid serious injury or death replace worn or damaged components immediately and keep the equipment out of use until repair is completed.







Inspect cables and belts

Inspect all cables and belts for wear or damage and proper tension. When inspecting cables and belts, run fingers on the cable or belt, paying particular attention to bends in cables and attachment points. The following conditions may indicate a worn cable:

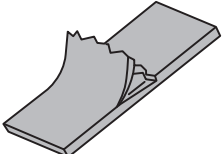
Cables

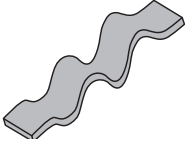
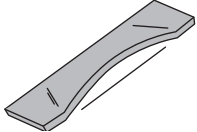
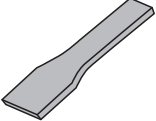
Condition of Cable	Diagram
A tear or crack in the cable sheath that exposes the cable	<p>A horizontal line representing a cable. In the middle, there is a small gap where the outer sheath is missing, exposing the inner core. The gap is shaded with diagonal lines to indicate the exposed interior.</p>
A kink in the cable	<p>A horizontal line representing a cable. It has a sharp V-shaped bend or kink in the middle, where the line crosses itself.</p>
A curled sheath	<p>A horizontal line representing a cable. The line is wavy and curved, showing an irregular, non-straight shape.</p>
Necking - A stretched cable sheath	<p>A horizontal line representing a cable. The middle section is significantly thinner than the ends, indicating that the sheath has been stretched and narrowed.</p>

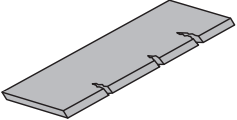
Belts

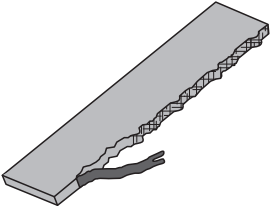
Condition of Belt	3D View	3D or Side View
Peeling of the belt's skin.		
Wave in belt		
Belt is necked down (narrow section)	<p data-bbox="654 627 979 779">Replace belt if any section is over 1/32" (.03) narrower than the rest of belt</p> 	<p data-bbox="995 627 1498 737">Examine edge of belt (both sides). Replace belt if any section is narrower than the rest.</p> 
Cracks or splits		
One or more strands of kevlar is hanging out, or if there is a significant amount of frayed kevlar.		



CAUTION: Worn handles

- Do not use handles if less than 1/8" of material remains on edge.
- Replace all worn handles immediately.

Inspect bars and handles for wear, paying particular attention to tab area connection points.

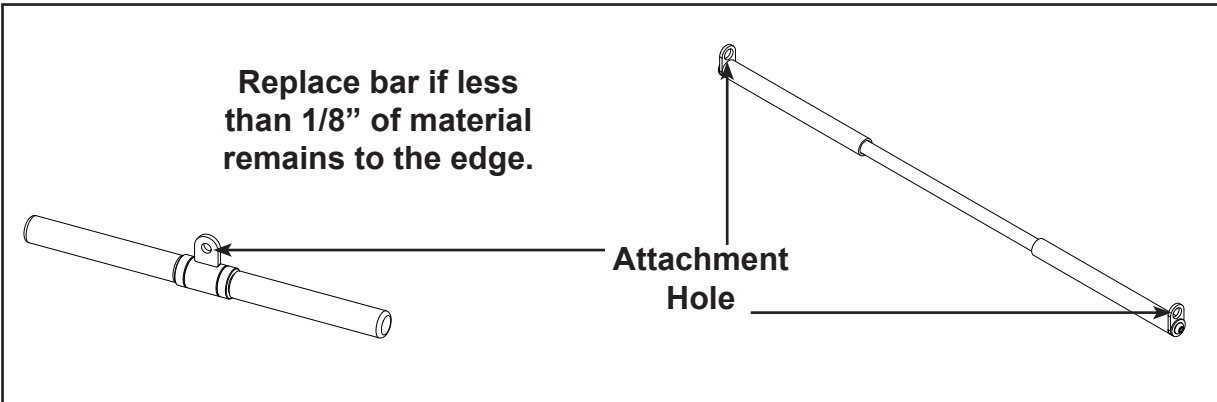

Inspection	Action
Inspect bars and handles for wear, paying particular attention to tab area connection points.	Replace all worn handles immediately.
Inspect snap links for proper latching (indicates wear).	Replace all loose or worn grips immediately.
Inspect all labeling for readability, including instructional placards, warning and caution decals.	Replace all worn labeling immediately.
Inspect all weight stacks for proper alignment and operation.	Correct all improper alignment and operation issues immediately.
Inspect guide rods for lubrication.	Wipe Weight Stack Guide Rods clean over entire length. Lubricate with a light coat of medium weight automotive engine oil.

Yearly Procedures

Replace all cables and belts annually

Cable Adjustment

Tools Required

9/16" Wrench (2)

Four types of cable tension adjustment are used on Cybox Strength Systems:

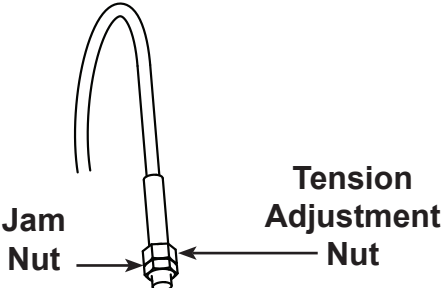
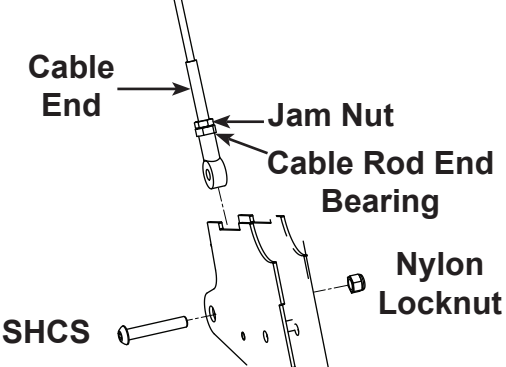
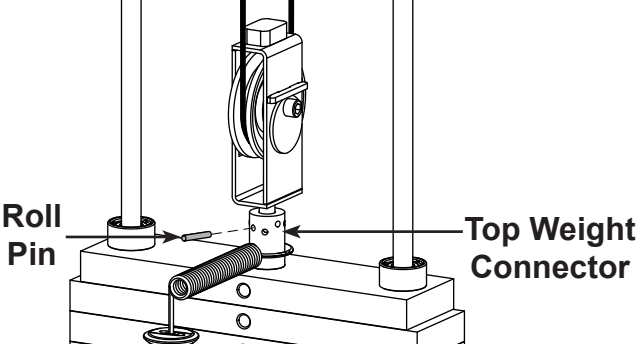
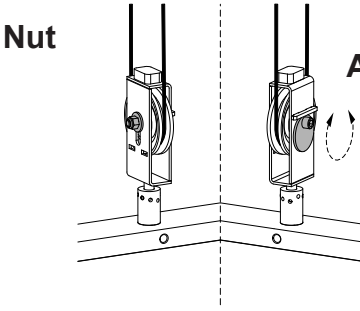
Cable Adjustment	Description	Diagram
Jam Nut Adjustment	This type of adjustment uses a jam nut and a tension adjustment nut at the cable cam end as the primary adjustment. The other end of the cable usually contains a roll pin adjustment.	 <p>The diagram shows a cable with a curved end. A 'Jam Nut' is positioned on the cable, and a 'Tension Adjustment Nut' is positioned next to it. Arrows point from the labels to the respective nuts.</p>
Rod End Adjustment	This type of adjustment uses a socket head cap screw (SHCS) securing a cable rod end bearing to the machine. Primary adjustment is by turning the rod end bearing. The other end of the cable usually contains a roll pin cable adjustment.	 <p>The diagram shows a cable rod end bearing assembly. Labels include 'Cable End', 'Jam Nut', 'Cable Rod End Bearing', 'SHCS' (socket head cap screw), and 'Nylon Locknut'. Arrows point from the labels to the corresponding parts.</p>
Roll Pin Adjustment	This type of adjustment uses a roll pin and series of holes in the weight stack top weight connector.	 <p>The diagram shows a weight stack with a 'Top Weight Connector'. A 'Roll Pin' is shown being inserted into one of the holes in the connector. Arrows point from the labels to the roll pin and the connector.</p>
Cam End Adjustment	This type of adjustment uses an adjustment bolt on the pulley bracket. Loosen nut and rotate cam bolt to adjust cable.	 <p>The diagram shows a pulley bracket with a 'Nut' and a 'Cam Bolt Adjustment'. A dashed line indicates the rotation of the cam bolt. Arrows point from the labels to the nut and the cam bolt.</p>

Belt Adjustment

Tools Required

- 7/32" Wrench
- Torque wrench (lbs-in)

Belt Adjustment	Action
Loose Belt	<ol style="list-style-type: none"> 1. Using a 7/32" Allen wrench loose set screws. 2. Pull belt tight. 3. Secure belt in place with set screws. 4. Torque set screws to 300-350 lb-in. 5. Verify that the belt is moving smoothly and is routed straight from the top pulley bracket to the to weight belt clamp

Customer Service

Product Registration

To register product do the following:

1. Visit www.cybexintl.com.
2. Locate Product Registration in the Support section.
3. Fill out form completely.
4. Click the Submit button to register product.

Contacting Service

Hours of phone service are Monday through Friday from 8:30 a.m. to 6:00 p.m. Eastern Standard Time.

For Cybex customers living in the USA, contact Cybex Customer Service at 888-462-9239.

For Cybex customers living outside the USA, contact Cybex Customer Service at 508-533-4300 or fax 508-533-5183. Email address internationaltechhelp@cybexintl.com

Find information on the web at www.cybexintl.com.

To contact us online go to www.cybexintl.com.

Ordering Parts

To order parts online go to www.cybexintl.com.

To speak with a customer service representative, call 888-462-9239 (for customers living within the USA) or 508-533-4300 (for customers outside the USA).

The following information located on the serial number decal will assist our Cybex representatives in serving you.

- Unit Serial Number, Product Name and Model Number
- Part Description and Part Number if you have it. All parts can be found on the web at www.cybexintl.com
- Shipping Address
- Contact Name
- Include a description of the problem.

In addition to your shipping address and contact name, your account number is helpful but not required. You may also fax orders to 508-533-5183.

Return Material Authorization (RMA)

The Return Material Authorization (RMA) system is used when returning material for placement, repair or credit. The system assures that returned materials are properly handled and analyzed. Follow the following procedures carefully.

Contact your authorized Cybex dealer on all warranty-related matters. Your local Cybex dealer will request a RMA from Cybex, if applicable. Under no circumstances will defective parts or equipment be accepted by Cybex without proper RMA and an Automated Return Service (ARS) label.

Please contact Cybex Customer Service for the return of any item that is defective.

Provide the technician with a detailed description of the problem you are having or the defect in the item you wish to return. Provide the model and serial number of your Cybex equipment.

At Cybex's discretion, the technician may request that you return the problem part(s) to Cybex for evaluation and repair or replacement. The technician will assign you a RMA number and will send you an ARS label. The ARS label and the RMA numbers must be clearly displayed on the outside of the package that contains the item(s) to be returned. Include the description of the problem, the serial number of the equipment and the name and address of the owner in the package along with the part(s).

Merchandise returned without an RMA number on the outside of the package or shipments sent COD will not be accepted by the Cybex receiving department.

Damaged Parts

Materials damaged in shipment should not be returned for credit. Shipping damages are the responsibility of the carrier (UPS, Federal Express, trucking companies, etc.)

Apparent Damage

Upon receipt of your shipment, check all items carefully. Any damage seen with a visual check must be noted on the freight bill and signed by the carrier's agent. Failure to do so will result in the carriers refusal to honor your damage claim. The carrier will provide you with the required forms for filing such claims.

Concealed Damage

Damage not seen with a visual check upon receipt of a shipment but notices later must be reported to the carrier as soon as possible. Upon discovery of the damage, a written or phone request to the carrier asking them to perform an inspection of the materials must be made within ten days of the delivery date. Keep all shipping containers and packing materials as they will be needed in the inspection process. The carrier will provide you with an inspection report and the necessary forms for filing a concealed damage claim. Concealed damage claim is the carrier's responsibility.



10 Trotter Drive Medway, MA 02053 • 508-533-4300 • FAX 508-533-5183
www.cybexintl.com