

# Club Series Cross-Trainer (CSX)

Operation Manual



## CORPORATE HEADQUARTERS

Columbia Centre III, 9525 West Bryn Mawr Avenue, Rosemont, Illinois 60018 • U.S.A.

847.288.3300 • FAX: 847.288.3703

Service phone number: 800.351.3737 (toll-free within U.S.A., Canada)

Global Website: [www.lifefitness.com](http://www.lifefitness.com)

## INTERNATIONAL OFFICES

### AMERICAS

#### North America Life Fitness, Inc.

Columbia Centre III  
9525 West Bryn Mawr Avenue  
Rosemont, IL 60018 U.S.A  
Telephone: (847) 288 3300  
Fax: (847) 288 3703  
Service Email:  
[customersupport@lifefitness.com](mailto:customersupport@lifefitness.com)  
Service Website: [www.lifefitness.com/parts](http://www.lifefitness.com/parts)  
Sales/Marketing Email:  
[consumerproducts@lifefitness.com](mailto:consumerproducts@lifefitness.com)  
Operating Hours: 7:00 am-6:00 pm (CST)

#### Brazil Life Fitness Brasil

Av. Cidade Jardim, 900  
Jd. Paulistano  
São Paulo, SP 01454-000  
BRAZIL  
SAC: 0800 773 8282  
Telephone: +55 (11) 3095 5200  
Fax: +55 (11) 3095 5201  
Service Email: [suporte@lifefitness.com.br](mailto:suporte@lifefitness.com.br)  
Sales/Marketing Email:  
[lifefitness@lifefitness.com.br](mailto:lifefitness@lifefitness.com.br)  
Service Operating Hours:  
9:00 - 17:00 (BRT) (Monday-Friday)  
Store Operating Hours:  
9:00 -20:00 (BRT) (Monday-Friday)  
10:00 - 16:00 (BRT) (Saturday)

#### Latin America & Caribbean\* Life Fitness Inc.

Columbia Centre III  
9525 West Bryn Mawr Avenue  
Rosemont, IL 60018 U.S.A  
Telephone: (847) 288 3300  
Fax: (847) 288 3703  
Service Email:  
[customersupport@lifefitness.com](mailto:customersupport@lifefitness.com)  
Sales/Marketing Email:  
[consumerproducts@lifefitness.com](mailto:consumerproducts@lifefitness.com)  
Operating Hours: 7:00am-6:00pm (CST)

### EUROPE, MIDDLE EAST, & AFRICA

#### (EMEA)

#### Netherlands & Luxemburg Life Fitness Atlantic BV

Bijdorpplein 25-31  
2992 LB Barendrecht  
THE NETHERLANDS  
Telephone: (+31) 180 646 666  
Fax: (+31) 180 646 699  
Service Email:  
[service.benelux@lifefitness.com](mailto:service.benelux@lifefitness.com)  
Sales/Marketing Email:  
[marketing.benelux@lifefitness.com](mailto:marketing.benelux@lifefitness.com)  
Operating Hours: 9.00h-17.00h (CET)

#### United Kingdom & Ireland Life Fitness UK LTD

Queen Adelaide  
Ely, Cambs, CB7 4UB  
Telephone: General Office (+44)  
1353.666017  
Customer Support (+44) 1353.665507  
Fax: (+44) 1353.666018  
Service Email: [uk.support@lifefitness.com](mailto:uk.support@lifefitness.com)  
Sales/Marketing Email: [life@lifefitness.com](mailto:life@lifefitness.com)  
Operating Hours:  
General Office: 9.00am - 5.00pm (GMT)  
Customer Support: 8.30am - 5.00pm  
(GMT)

#### Germany & Switzerland Life Fitness Europe GMBH

Siemensstraße 3  
85716 Unterschleißheim  
GERMANY  
Telephone: (+49) 89.31 77 51.0 (Germany)  
(+41) 0848 000 901 (Switzerland)  
Fax: (+49) 89.31 77 51.99 (Germany)  
(+41) 043 818 07 20 (Switzerland)  
Service Email:  
[kundendienst@lifefitness.com](mailto:kundendienst@lifefitness.com)  
Sales/Marketing Email:  
[kundenberatung@lifefitness.com](mailto:kundenberatung@lifefitness.com)  
Operating Hours: 08.30 -16.30h (CET)

#### Austria Life Fitness Austria

Vertriebs G.m.b.H.  
Dückerstraße 7-9/3/36  
1220 Vienna  
AUSTRIA  
Telephone: (+43) 1.61.57.198  
Fax: (+43) 1.61.57.198.20  
Service Email: [kundendienst@lifefitness.com](mailto:kundendienst@lifefitness.com)  
Marketing/Sales Email:  
[kundenberatung@lifefitness.com](mailto:kundenberatung@lifefitness.com)  
Operating Hours: 08:30-16.30.h (MEZ)

#### Spain Life Fitness IBERIA

C/Frederic Mompou 5,1ªª  
08960 Sant Just Desvern Barcelona  
SPAIN  
Telephone: (+34) 93.672.4660  
Fax: (+34) 93.672.4670  
Service Email: [servicio.tecnico@lifefitness.com](mailto:servicio.tecnico@lifefitness.com)  
Sales/Marketing Email:  
[info.iberia@lifefitness.com](mailto:info.iberia@lifefitness.com)  
Operating Hours:  
9.00h-18.00h (Monday-Thursday)  
8.30h-15.00h (Friday)

#### Belgium Life Fitness Benelux NV

Parc Industriel de Petit-Rechain  
4800 Verviers  
BELGIUM  
Telephone: (+32) 87 300 942  
Fax: (+32) 87 300 943  
Service Email:  
[service.benelux@lifefitness.com](mailto:service.benelux@lifefitness.com)  
Sales/Marketing Email:  
[marketing.benelux@lifefitness.com](mailto:marketing.benelux@lifefitness.com)  
Operating Hours: 9.00h -17.00h (CET)

#### All Other EMEA Countries & Distributor Business C-EMEA\*

Bijdorpplein 25-31  
2992 LB Barendrecht  
THE NETHERLANDS  
Telephone: (+31) 180 646 644  
Fax: (+31) 180 646 699  
Service Email:  
[service.db.cemea@lifefitness.com](mailto:service.db.cemea@lifefitness.com)  
Sales/Marketing Email:  
[marketing.db.cemea@lifefitness.com](mailto:marketing.db.cemea@lifefitness.com)  
Operating Hours: 9.00h-17.00h (CET)

### ASIA PACIFIC (AP)

#### Japan Life Fitness Japan

Japan Nippon Brunswick Bldg., #8F  
5-27-7 Sendagaya  
Shibuya-Ku, Tokyo  
Japan 151-0051  
Telephone: (+81) 3.3359.4309  
Fax: (+81) 3.3359.4307  
Service Email: [service@lifefitnessjapan.com](mailto:service@lifefitnessjapan.com)  
Sales/Marketing Email:  
[sales@lifefitnessjapan.com](mailto:sales@lifefitnessjapan.com)  
Operating Hours: 9.00h-17.00h (JAPAN)

#### Hong Kong Life Fitness Asia Pacific LTD

32/F, Global Trade Square  
21 Wong Chuk Hang Road  
HONG KONG  
Telephone: (+852) 2575.6262  
Fax: (+852) 2575.6894  
Service Email:  
[HongKongEnquiry@lifefitness.com](mailto:HongKongEnquiry@lifefitness.com)  
Sales/Marketing Email:  
[Marketing.HK.Asia@lifefitness.com](mailto:Marketing.HK.Asia@lifefitness.com)  
Operating Hours: 9.00h-17.00h  
Service Operating Hours: 9.00h-18.00h

#### All Other Asia Pacific countries & distributor business Asia Pacific\* Life Fitness Asia Pacific LTD

32/F, Global Trade Square  
21 Wong Chuk Hang Road  
HONG KONG  
Telephone: (+852) 2575.6262  
Fax: (+852) 2575.6894  
Service Email:  
[HongKongEnquiry@lifefitness.com](mailto:HongKongEnquiry@lifefitness.com)  
Sales/Marketing Email:  
[Marketing.HK.Asia@lifefitness.com](mailto:Marketing.HK.Asia@lifefitness.com)  
Operating Hours: 9.00h-17.00h  
Service Operating Hours: 9.00h-18.00h

\* Also check [www.lifefitness.com](http://www.lifefitness.com) for local representation or distributor/dealer

# Table of Contents

---

Important Safety Instructions	5
1 Setup	9
2 Console Overlay and Activity Zone	10
2.1 Console Overlay and Activity Zone Overview	10
2.2 Console Overlay and Activity Zone Descriptions	11
2.3 Reading Rack and Accessory Trays	14
3 Heart Rate Zone Training®	15
3.1 Why Heart Rate Zone Training Exercise?	15
3.2 Heart Rate Monitoring	16
4 Workouts	17
4.1 Workout Overview	17
4.2 Using the Workouts	18
4.3 Workout Descriptions	21
4.4 Using My Workouts Personal Programs	29
5 User Menu (Optional Settings)	30
5.1 Entering and Using the Service Menu	30
5.2 Manager's Configuration (Optional Settings)	31
6 Service and Technical Data	33
6.1 Preventive Maintenance Tips	33
6.2 Preventive Maintenance Schedule	34
6.3 Troubleshooting the Optional Polar® Telemetry Heart Rate Chest Strap	35
6.4 Troubleshooting the Lifepulse™ System Sensors	35
6.5 How to Obtain Product Service / Serial Number Location	35
7 Specifications	36
8 Warranty	37

© 2015 Life Fitness, A division of Brunswick Corporation. All Rights Reserved. Life Fitness is a registered trademark of Brunswick Corporation. Fitlinxx is a trademark of Fitlinxx, Inc. Polar is a registered trademark of Polar Electro, Inc. iPod® and iPhone® are registered trademarks of Apple, Inc. Gym Wipes® is a registered trademark of The 2XL Corporation. PureGreen 24 is a trademark of Pure Green.

Before using this product, it is essential to read this ENTIRE operation manual and ALL installation instructions. It describes equipment setup and instructs members on how to use it correctly and safely.

Avant d'utiliser ce produit, il est indispensable de lire ce manuel d'utilisation dans son INTÉGRALITÉ, ainsi que TOUTES les instructions d'installations.

Ce manuel explique comment installer l'équipement et comment l'utiliser correctement et sans danger.

Class HB (Home): Domestic use.

FCC Warning - Possible Radio / Television Interference

**NOTE:** This equipment has been tested and found to comply with the limits for a Class B digital device, pursuant to part 15 of the FCC rules. These limits are designed to provide reasonable protection against harmful interference in a residential installation. This equipment generates, uses and can radiate radio frequency energy, and if not installed and used in accordance with the user manual, may cause harmful interference to radio communications. However, there is no guarantee that the interference will not occur in a particular installation. If this equipment does cause harmful interference to radio or television reception, which can be determined by turning the equipment off and on, the user is encouraged to try to correct the interference by one or more of the following measures:

- Re-orient or relocate the receiving antenna.
- Increase the separation between the equipment and the receiver.
- Connect the equipment into an outlet on a circuit different from that to which the receiver is connected.
- Consult the dealer or an experienced radio/TV technician for help.



**CAUTION: Any changes or modifications to this equipment could void the product warranty.**

**Mise en garde : tout changement ou toute modification de ce matériel peut annuler la garantie du produit.**

Any service, other than cleaning or user maintenance, must be performed by an authorized service representative.

This Operation Manual describes the functions of the following product:

### **Club Series Cross-Trainer (CSX)**

See "Specifications" in this manual for product specific features.

**Statement of Purpose:** The Life Fitness Cross-Trainer is an exercise machine that combines low-impact elliptical pedaling with push/pull arm motion to provide an efficient, effective total body workout.



**CAUTION: Life Fitness STRONGLY recommends seeing a physician for a complete medical exam before undertaking an exercise program, particularly if the user has a family history of high blood pressure or heart disease, is over the age of 45, smokes, has high cholesterol, is obese, or has not exercised regularly in the past year.**

If, at any time while exercising, the user experiences faintness, dizziness, pain, or shortness of breath, he or she must stop immediately.





**MISE EN GARDE: Life Fitness recommande FORTEMENT de consulter un médecin pour subir un examen médical complet avant de commencer tout programme d'exercice, et tout particulièrement si l'utilisateur a des antécédents familiaux d'hypertension ou de troubles cardiaques, s'il a plus de 45 ans, s'il fume, s'il a du cholestérol, s'il est obèse ou n'a pas fait d'exercice régulièrement depuis un an.**

Si, pendant l'utilisation de l'appareil, l'utilisateur ressent un malaise, des vertiges, des douleurs ou des vertiges, des douleurs ou des difficultés à respirer, il doit s'arrêter immédiatement.

# IMPORTANT SAFETY INSTRUCTIONS

Read all instructions before using the LIFE FITNESS cross-trainer.

 **DANGER:** To reduce the risk of electrical shock, always unplug Life Fitness product before cleaning or attempting any maintenance activity.

 **WARNING:** To reduce the risk of burns, fire, electric shock, or injury, it is imperative to connect the product to a properly grounded electrical outlet.

 **WARNING:** Heart rate monitoring systems may be inaccurate. Over exercising may result in serious injury or death. If you feel faint, stop exercising immediately.

 **WARNING:** Keep the area around the cross-trainer clear of any obstructions, including walls and furniture. Make sure there are 2 feet (0.6 meters) on each side of the cross-trainer.

 **CAUTION:** Any changes or modifications to this product could void the product warranty.

 **The heart rate hand pulse sensors provide an approximate heart rate value. The sensors are not medical devices and should not be used in any type of medical application.**

- To disconnect, turn power OFF at the ON/OFF switch, then remove plug from electrical outlet.
- Never operate a Life Fitness product if it has a damaged power cord or electrical plug, or if it has been dropped, damaged, or even partially immersed in water. Contact Life Fitness Customer Support Services.
- Position the product so that the power cord plug to the wall is accessible to the user. Make sure the power cord is not knotted or twisted and that it is not trapped under any equipment or other objects.
- If the electrical supply cord is damaged, it must be replaced by the manufacturer, an authorized service agent, or a similarly qualified person to avoid a hazard.
- Always follow the console instructions for proper operation.
- This appliance is not intended for use by persons (including children) with reduced physical, sensory, or mental capabilities, or lack of experience or knowledge unless they have supervision or been given instruction concerning the use of the appliance by a person responsible for their safety.
- Do not use this product outdoors, near swimming pools or in areas of high humidity.
- Never operate a Life Fitness product with the air openings blocked. Keep air openings free of lint, hair, or any other obstructing material.
- Never insert objects into any opening in this product. If an object should drop inside, turn off the power, unplug the power cord from the outlet, and carefully retrieve it. If the item cannot be reached, contact Life Fitness Customer Support Services.
- Never place liquids of any type directly on the unit, except in an accessory tray or holder. Containers with lids are recommended.
- Do not use these products in bare feet. Always wear shoes. Wear shoes with rubber or high-traction soles. Do not use shoes with heels, leather soles, cleats or spikes. Make sure no stones are embedded in the soles.
- Keep all loose clothing, shoelaces, and towels away from moving parts.

- Do not reach into, or underneath, the unit or tip it on its side during operation.
- Do not allow other people to interfere in any way with the user or equipment during a workout.
- Allow LCD consoles to “normalize” with respect to temperature for one hour before plugging the unit in and using.
- Use these products for their intended use as described in this manual. Do not use attachments that have not been recommended by the manufacturer.
- Keep the power cord away from heated surfaces. Do not pull the equipment by the power cord or use the cord as a handle. Do not run the power cord on the floor under or along the side of the cross-trainer.
- Use caution when mounting or dismounting the cross-trainer. Use the stationary handlebars whenever additional stability is required. While exercising, hold onto the moving arms.
- Never use the cross-trainer while facing backward.
- Keep hands and feet away from all moving parts.
- Use this product in a well-ventilated area.
- Use this product on a solid, level surface.
- Make sure that all components are fastened securely.
- An appliance should never be left unattended when plugged in. Unplug from outlet when not in use, and before putting on or taking off parts.
- Do not operate under blanket or pillow. Excessive heating can occur and cause fire, electric shock, or injury to persons.
- Do not sit or stand on the pedal lever covers or motor housing.
- Children should be supervised to ensure they do not play with the product.
- Read all warnings on each product prior to starting a workout.
- Health and Environmental Regulations Warning - This product may contain chemicals known to the State of California to cause cancer, birth defects, or other reproductive harm. For more information related to the European Commission Regulation (EC) No. 1907/2006 (REACH) and the California Safe Drinking Water and Toxic Enforcement Act of 1986 (Proposition 65), please visit <https://www.lftechsupport.com/web/guest/environmental-regulations-information>.

**SAVE THESE INSTRUCTIONS FOR  
FUTURE REFERENCE.**

# CONSIGNES DE SÉCURITÉ IMPORTANTES

Lire toutes les instructions avant d'utiliser le tapis roulant.



**DANGER:** Pour réduire les risques de décharge électrique, toujours débrancher cet appareil Life Fitness avant le nettoyage ou toute mesure d'entretien.

- **AVERTISSEMENT:** Pour réduire les risques de brûlures, d'incendies, de décharges électriques ou de blessures, chaque appareil doit absolument être branché sur une prise électrique correctement mise à la terre.
- **AVERTISSEMENT:** Des systèmes de surveillance de fréquence cardiaque peuvent être inexacts. Trop d'exercices peuvent entraîner des blessures sérieuses, voire mortelles. En cas de sensation d'évanouissement, arrêter immédiatement l'entraînement.
- **AVERTISSEMENT:** Conserver une zone de 2 m sur 1 m libre de toute obstruction derrière le tapis roulant (aucun mur, meuble ou autre appareil).
- **AVERTISSEMENT:** S'assurer que la dragonne d'arrêt d'urgence est attachée à l'utilisateur et fixée adéquatement au tapis roulant avant de commencer un exercice.
- **AVERTISSEMENT:** Le réglage de centrage de la courroie doit être effectué si la courroie ne se trouve pas entre les repères indiquant les positions latérales maximum permises. Reportez-vous à la Section 6.6.
- **MISE EN GARDE:** Risque de blessures corporelles - Pour éviter de se blesser, faire preuve d'extrême prudence lors de la montée ou descente de la courroie en mouvement. Lire les instructions avant tout usage de l'appareil.
- **MISE EN GARDE:** Tout changement et toute modification de ce matériel peut annuler la garantie du produit.
  - Pour débrancher, mettre l'appareil hors tension au niveau de l'interrupteur d'alimentation, puis retirer la fiche de la prise électrique.
  - Ne jamais faire fonctionner un produit Life Fitness dont la fiche ou le cordon d'alimentation est endommagé, ni aucun appareil qui serait tombé ou aurait été endommagé ou même partiellement plongé dans l'eau. Appeler le service clientèle de Life Fitness.
  - Placer ce produit de manière à ce que l'utilisateur puisse accéder à la fiche du cordon d'alimentation.
  - Si le cordon d'alimentation électrique est endommagé, il doit être remplacé par le fabricant, par un réparateur agréé ou par une personne qualifiée afin d'éviter tout danger.
  - Les instructions de la console doivent toujours être suivies pour obtenir un fonctionnement correct.
  - Cet appareil n'est pas prévu pour être utilisé par des personnes (y compris les enfants) dont les capacités physiques, sensorielles ou mentales sont réduites, ou des personnes dénuées d'expérience ou de connaissance, sauf si elles ont pu bénéficier, par l'intermédiaire d'une personne responsable de leur sécurité, d'une surveillance ou d'instructions préalables concernant l'utilisation de l'appareil.



- Ne pas utiliser ce produit à l'extérieur, près d'une piscine ou dans des endroits très humides.
- Ne jamais faire fonctionner d'appareil Life Fitness dont les orifices d'aération seraient bloqués. Les garder exempts de peluches, de cheveux ou de toute obstruction.
- Ne jamais rien insérer dans les ouvertures de cet appareil. Si un objet tombe à l'intérieur de l'appareil, couper l'alimentation électrique, débrancher le cordon de la prise et le récupérer avec précaution. S'il est impossible de l'atteindre, communiquer avec le service à la clientèle de Life Fitness.
- Ne jamais placer aucun liquide directement sur l'appareil, sauf dans le plateau pour accessoires ou un support prévu à cet effet. Il est recommandé d'utiliser des conteneurs munis de couvercles.
- Ne pas utiliser cet appareil pieds nus. Toujours porter des chaussures. Porter des chaussures avec des semelles en caoutchouc ou fournissant une très bonne adhérence. Ne pas utiliser de chaussures à talons, à semelles en cuir ou munies de crampons. S'assurer qu'aucun caillou n'est incrusté dans les semelles.
- Éloigner les vêtements lâches, les lacets et les serviettes des pièces en mouvement.
- Ne pas placer les mains sous l'appareil ou dans l'appareil, et ne pas le renverser sur le côté pendant le fonctionnement.
- Ne laisser personne déranger de quelque manière que ce soit l'utilisateur ou interférer avec l'équipement durant un entraînement.
- Laisser les consoles ACL se « normaliser » pendant une heure quant à la température avant le branchement et l'utilisation de l'appareil.
- Cet appareil ne doit être employé que pour l'usage auquel il est destiné, conformément aux directives du manuel. Ne pas utiliser d'accessoires qui ne sont pas recommandés par le fabricant.
- Tenir le cordon d'alimentation à l'écart de toute surface chauffée. Ne pas tirer l'appareil par le cordon d'alimentation; ne pas utiliser le cordon comme poignée. Ne pas faire passer le cordon sur le sol, sous le tapis roulant, ni le long de l'appareil. Reportez-vous à la Section 2.5 pour la disposition adéquate du cordon d'alimentation.
- Les rampes latérales peuvent servir à rétablir son équilibre, mais ne sont pas destinées à un usage continu.
- Ne jamais monter sur le tapis de course et ne pas en descendre jamais pendant qu'il tourne. Utiliser les rampes latérales afin de ne pas perdre l'équilibre. En cas d'urgence, par exemple, en cas de trébuchement ou de faux pas, saisir les barres latérales et placer les pieds sur les plates-formes latérales.
- Ne jamais marcher ni courir à reculons sur le tapis roulant.
- S'il est nécessaire d'immobiliser le tapis roulant, régler l'afficheur sur SELECT WORKOUT (SÉLECTIONNER EXERCICE). (Appuyer deux fois sur la touche Remise à zéro si l'afficheur n'en est pas déjà à ce point.) Maintenir ensuite la touche SPEED DOWN (RALENTISSEMENT) enfoncée et appuyer sur la touche PAUSE. L'appareil affiche désormais IMMOBILIZED (Immobilisé). Il ne peut alors plus fonctionner, Le moteur principal, le moteur en ligne et le cireur sont désactivés. Le tapis roulant restera immobilisé, même s'il est réinitialisé, mis hors tension, puis remis sous tension, etc. Le mode de fonctionnement normal ne peut être rétabli qu'au moyen de la même séquence de touches : maintenir la touche SPEED DOWN (RALENTISSEMENT) enfoncée et appuyer sur PAUSE. L'appareil affichera SELECT WORKOUT (SÉLECTIONNER EXERCICE) à nouveau.
- Lisez tous les avertissements sur chaque produit avant de démarrer un exercice.
- Règlementation en matière de santé et d'environnement : avertissement - Ce produit peut contenir des substances chimiques considérées par l'État de Californie comme cancérogènes et causant des malformations congénitales ou d'autres troubles de l'appareil reproducteur. Pour plus d'informations sur la réglementation européenne n° 1907/2006 (REACH) et le California Safe Drinking Water and Toxic Enforcement Act de 1986 (Proposition 65), connectez-vous à l'adresse suivante : <https://www.lftechsupport.com/web/guest/environmental-regulations-information>.

**CONSERVER CES INSTRUCTIONS  
POUR TOUT USAGE ULTÉRIEUR.**

# 1 SETUP

Read the Operation Manual before setting up the Life Fitness Cross-Trainer.

## Where to Place the Life Fitness Cross-Trainer

Follow all safety instructions and move the Life Fitness Cross-Trainer to the location in which it will be used. See Section 7 for the dimensions of the footprint. Allow 2 feet (0.6 meters) of clearance around the Life Fitness Cross-Trainer to allow for movement of the pedal levers. It should be easy to mount the Life Fitness Cross-Trainer from the side.

## How to Stabilize the Life Fitness Cross-Trainer

After placing the Life Fitness Cross-Trainer in position, check the unit's stability by attempting to rock it. Any slight rocking indicates that the unit must be leveled. Check the stabilizing feet to determine which foot does not rest fully on the floor. Rotate the foot counter-clockwise to lower it. Recheck the stability and adjust again as needed until the Life Fitness Cross-Trainer is stable and no longer rocks. Lock the adjustment into position by tightening the jam nut against the stabilizer bar with an open end 9/16 inch wrench.

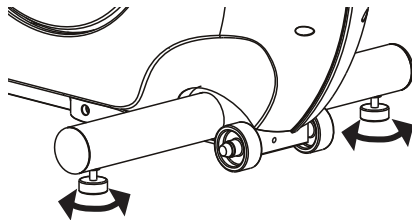

## Plug In the Life Fitness Cross-Trainer (*DOMESTIC UNITS ONLY*)

The Life Fitness Cross-Trainer comes with a standard power supply. Insert the power adapter jack into the barrel plug on the back of the Life Fitness Cross-Trainer. Then insert the power supply into the wall outlet. Make sure the cord is routed so that it doesn't bind and will not be walked on. Check that the console LEDs light up. If not, recheck the plug and wall connections and make sure the wall outlet has power.

**Note:** *International units are self-powered only.* Use only the power supply provided by Life Fitness in order to insure against unsafe operation.

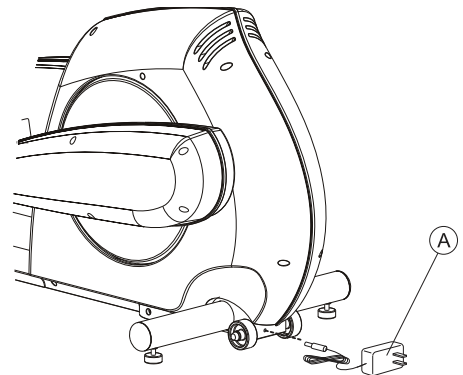

## Service Access Port

The two interchangeable type RJ45 networking ports (A) are located on the back of the display console. These network ports, located behind the display console rear access door, allow for console software updates.



# 2 Console Overlay and Activity Zone

## 2.1 Console Overlay Overview

The computerized display console on the cross-trainer allows the user to tailor a workout to personal fitness abilities and goals and to monitor progress. With this easy-to-use console, the user can track fitness improvement from one workout to another.

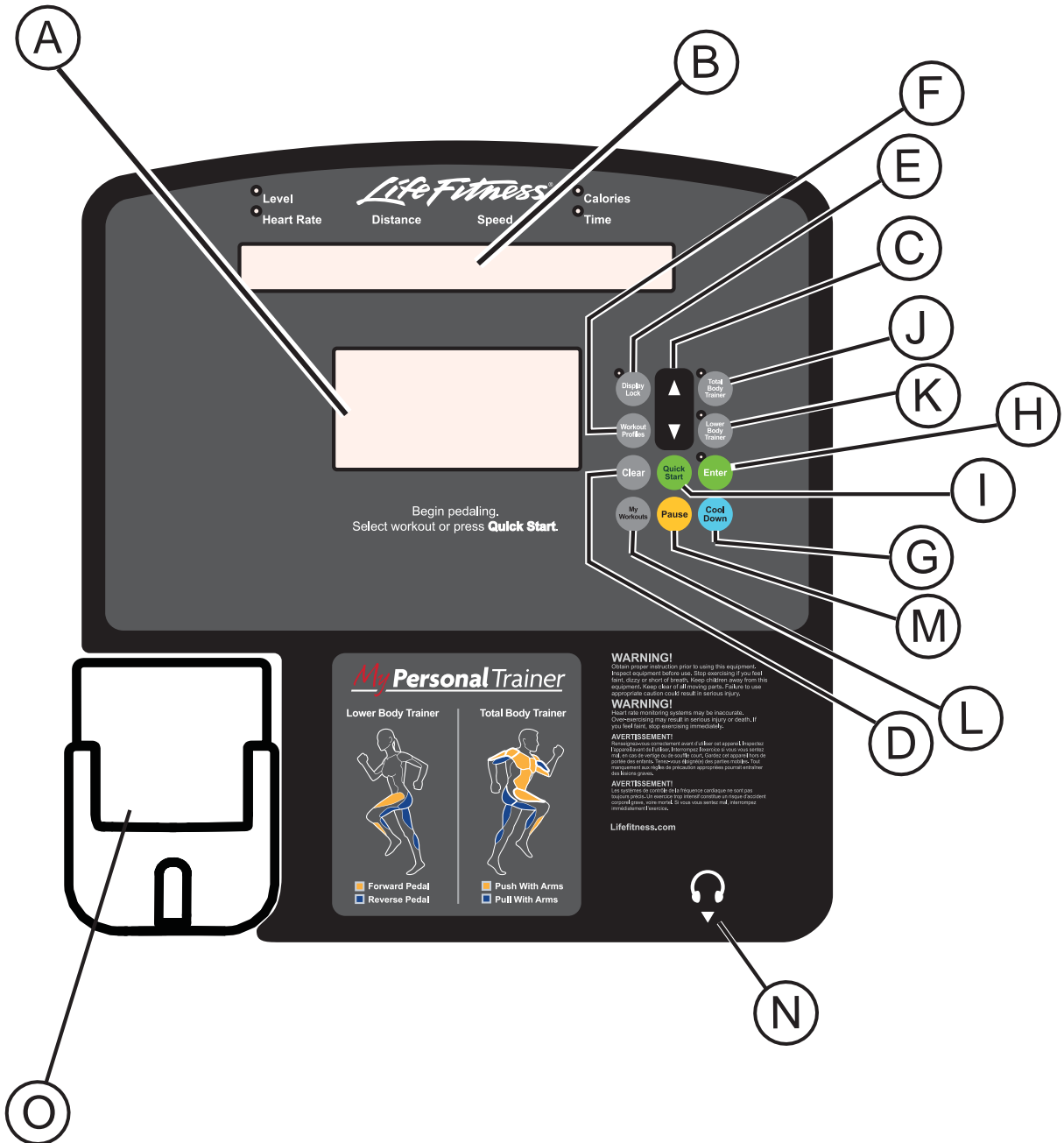

## 2.2 Console Overlay Descriptions

- A. **WORKOUT PROFILE WINDOW:** This window displays shapes, made of columns of lights, that represent the levels of intensity in a workout-in-progress. The height of the first column on the left side of the window is proportional to the current level of intensity.

During a FAT BURN, CARDIO, HEART RATE HILL, HEART RATE INTERVAL, or EXTREME HEART RATE workout, which requires the use of a Polar® telemetry heart rate chest strap or the Lifepulse™ system sensors, the Workout Profile window displays a flashing heart shape to request the user's heart rate signal. If the console does not detect a signal, the MESSAGE CENTER displays the prompt "NEED HEART RATE - PLACE HANDS ON SENSORS OR USE TELEMETRY STRAP". If the console does not receive the signal within three minutes, the workout automatically is converted to a MANUAL program.

- B. **MESSAGE CENTER:** This window displays step-by-step instructions for setting up a workout. During a workout, it displays statistics about the progress of the workout:

- **Level:** programmed intensity level. Toggles with Heart Rate.
- **Heart Rate:** the detected heart rate if the user is wearing the Polar telemetry heart rate chest strap or grasping the Lifepulse system sensors.
- **Distance:** the total distance traveled in miles (or kilometers if enabled).
- **Speed:** the pedaling speed or rate in miles per hour (or kilometers per hour if enabled).
- **Calories:** the number of calories burned since beginning the workout. Toggles with Time.
- **Time:** time elapsed since the start of the workout. Toggles with Calories.

If configured to do so, the MESSAGE CENTER displays any or all of these three values each time the intensity level changes during the workout:

- **Calories per Hour:** the rate of calories burned per hour.
- **Watts:** effort level in Watts. The Watt is a unit of power output or the expression of the mechanical rate of work.
- **METs:** effort level in METs. The MET is an expression of the rate of work for the human body at rest, or a metabolic equivalent; one MET is approximately equal to the metabolism of a person at rest.

**NOTE:** *The Watts display and the Calories per Hour display cannot be turned on at the same time. See Section 5 for information about enabling the MESSAGE CENTER to display these additional settings.*

- C. **ARROW keys:** Use the UP and DOWN Arrow keys to change workout parameters displayed on the console, such as length of workout, weight, age, target heart rate, and intensity level. Pressing these keys during a FAT BURN, CARDIO, HEART RATE HILL, HEART RATE INTERVAL, or EXTREME HEART RATE workout increases or decreases the target heart rate.
- D. **CLEAR key:** Press this key, when programming a workout, to clear incorrect data, such as weight or age, before pressing the ENTER key. Pressing CLEAR during a workout stops it immediately, at which point, the MESSAGE CENTER displays a summary of the workout, including total time elapsed, total distance traveled, and total calories burned. Pressing CLEAR a second time causes the MESSAGE CENTER to prompt the user for a new workout setup.
- E. **DISPLAY LOCK:** During a workout, the MESSAGE CENTER alternately displays the number of CALORIES BURNED and the amount of TIME ELAPSED. Pressing the DISPLAY LOCK key when the MESSAGE CENTER displays either statistic, forces the MESSAGE CENTER to display that statistic continuously throughout the workout. Pressing DISPLAY LOCK again allows the MESSAGE CENTER to resume toggling between both statistics.
- F. **WORKOUT PROFILES keys:** Press this key to select workout options:
- MANUAL
  - EZ RESISTANCE
  - CARDIO
  - EXTREME HEART RATE
  - RANDOM
  - SPORTS TRAINING
  - HEART RATE HILL
  - TOTAL BODY
  - HILL
  - FAT BURN
  - HEART RATE INTERVAL
  - LOWER BODY
  - Six Preset Workouts: AROUND THE WORLD, CASCADES, FOOTHILLS, INTERVAL, KILIMANJARO, SPEED TRAINING
  - FIT TEST

- G. **COOL DOWN key:** Workout programs end automatically in a Cool Down mode, which lowers the intensity level. Press the COOL DOWN key at any desired point during a workout to go immediately into Cool Down mode. In this phase of a workout the body begins to remove lactic acid and other accumulated by-products of exercise, which build up in muscles during a workout and contribute to muscle soreness. The console automatically adjusts each workout's Cool Down level according to the individual user's performance.
- H. **ENTER key:** Press this key to confirm entries of workout setup values, as displayed in the MESSAGE CENTER.
- I. **QUICK START key:** Press this key to begin a MANUAL workout immediately, without having to select a workout program. Once the workout is in progress, use the ARROW keys to change the intensity level or workout duration as desired.
- J. **TOTAL BODY TRAINER:** Press this key to activate a workout mode in which the MESSAGE CENTER displays prompts to vary the workload and emphasize different muscle groups during the workout. It can be used with any workout, except for FAT BURN, CARDIO, HEART RATE HILL, HEART RATE INTERVAL, EXTREME HEART RATE, and EZ RESISTANCE.
- K. **LOWER BODY TRAINER:** Press this key to activate a workout mode that alternates five minutes of forward motion with two minutes of reverse motion. It can be used with any workout, except for FAT BURN, CARDIO, HEART RATE HILL, HEART RATE INTERVAL, EXTREME HEART RATE, and EZ RESISTANCE.
- L. **MY WORKOUTS:** Press this key to pre-set up to seven workouts with personal setup information, such as age or level, and then store the workouts in the console memory.
- M. **PAUSE:** Press this key once to pause workout data accumulation. Press again to resume workout.

**NOTE (INTERNATIONAL UNITS ONLY):** *The Cross-Trainer will go into Energy Saving Mode after five minutes of inactivity. To wake up the console: start to pedal, press QUICK START, or select a workout.*

- N. **iPod Keypad:** The keys are used to provide control of an iPod.
- O. **HEADPHONE JACK:** Headphones must be plugged into the cross-trainer to access the sound for the iPod. The jack is not a user-replaceable feature. Contact Life Fitness Customer Support Services for more information.
- P. **ipod HOLDER:** Users can attach an iPod via a 30-pin connector. Use the iPod keypad controls to play, or your iPod controls to select a song or video and begin playing.

## 2.3 Reading Rack and Accessory Trays

The WATER BOTTLE HOLDER (A) provides easy storage for water bottles. The ACCESSORY TRAY (B), which is mounted near the base of the console, provides a storage tray with space for items such as personal stereos and cell phones. Additionally, an integrated READING RACK (C) for allowing a book or magazine is located at the base of the upper panel of the console.

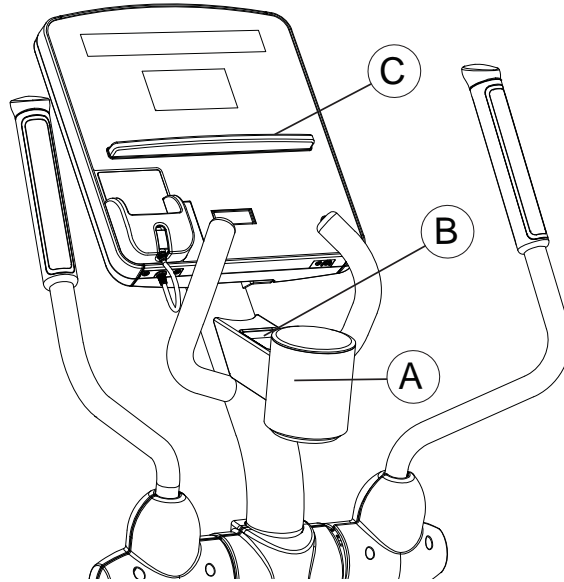

# 3 Heart Rate Zone Training®

## 3.1 Why Heart Rate Zone Training Exercise?

Research shows that maintaining a specific heart rate while exercising is the optimal way to monitor the intensity of a workout and to achieve maximum results. That is the idea behind the Life Fitness Heart Rate Zone Training® approach to exercise.

Zone Training identifies an exerciser’s ideal heart rate range, or zone, for burning fat or increasing cardiovascular fitness. The zone is a percentage of the theoretical maximum (HRmax), and its value depends on the workout. The maximal Heart Rate formula is defined by the American College of Sports Medicine’s “Guidelines for Exercise Testing and Prescription”, 8th Edition, 2010. HRmax equals to 206.9 minus the total of 0.67 multiplied by a person’s age.

$$\text{HR Max} = 206.9 - (0.67 * \text{age})$$

The Life Fitness Cross-Trainer features five exclusive workouts designed to take full advantage of the benefits of Heart Rate Zone Training+ exercise:

- FAT BURN
- HEART RATE HILL™
- EXTREME HEART RATE™
- CARDIO
- HEART RATE INTERVAL™

Each workout offers different benefits, as discussed in Section 4, *The Workouts*.

**NOTE:** Consulting a fitness trainer is recommended for defining specific fitness goals and designing a workout program.

To change the target heart rate during a workout, use the LEVEL arrow keys.  
To switch between programs during a workout, use the WORKOUT SELECTION KEYS.

The Heart Rate Zone Training® workout programs measure heart rate. Wear the optional Polar® telemetry heart rate chest strap, or grip the Lifepulse™ sensors, to enable the cross-trainer’s on-board computer to monitor the heart rate during a workout. The computer automatically adjusts the resistance level to maintain the target heart rate based on the actual heart rate.

Age	Theoretical Maximum Heart Rate	65% (Fat Burn)	80% (Cardio)
10	200	130	160
20	194	126	155
30	187	121	149
40	180	117	144
50	173	113	139
60	167	108	133
70	160	104	128
80	153	100	123
90	147	95	117
99	141	91	112

**NOTE:** Reference the above chart for Theoretical Maximum Heart Rates and Target Heart Rates.

## 3.2 Heart Rate Monitoring

### The Lifepulse™ Digital Heart Rate Monitoring System

The patented Lifepulse system sensors are the built-in heart rate monitoring system on the Life Fitness Cross-Trainer. For the most accurate reading possible, during a workout:

- Grasp the sensors (A) firmly.
- Hold each sensor at the vertical midpoint.
- Keep hands steady and in place.

The console displays the heart rate within 10 to 40 seconds after the user grasps the sensors. The following factors may affect a Lifepulse reading: incorrect hand placement on the sensors, upper body activity, lotion or dirt on hands, and excessive or insufficient pressure used when gripping the sensors.

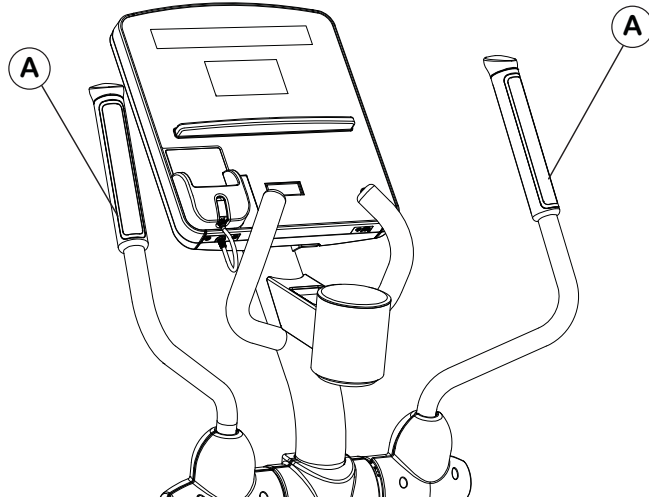

### The Optional Polar® Telemetry Heart Rate Chest Strap

The Life Fitness Cross-Trainer is equipped with Polar® telemetry, a heart rate monitoring system in which electrodes, pressed against the skin, transfer heart rate signals to the console. These electrodes are attached to a Polar telemetry heart rate chest strap that the user wears during the workout. The Polar telemetry heart rate chest strap is optional. Contact Life Fitness Customer Support Services to order.

See the diagram below for correct positioning of the Polar telemetry heart rate chest strap. The electrodes (A), which are the two grooved surfaces on the underside of the strap, must remain wet to transmit accurately the electrical impulses of the heart back to the receiver. Moisten the electrodes. Then, secure the Polar telemetry heart rate chest strap as high under the chest muscles as possible. The strap should be snug, but comfortable enough to allow for normal breathing.

The transmitter strap delivers an optimal heart rate reading when the electrodes are in direct contact with bare skin. However, it functions properly through a thin layer of wet clothing. If it becomes necessary to re-moisten the Polar telemetry heart rate chest strap electrodes, grasp the center of the strap, pull it away from the chest to expose the two electrodes, and re-moisten them.

**NOTE:** If the Lifepulse system sensors are grasped while the chest strap is worn, and if the signals from the sensors are valid, the on-board computer uses the sensor signals for calculating the heart rate instead of those transmitted with the Polar telemetry heart rate chest strap.

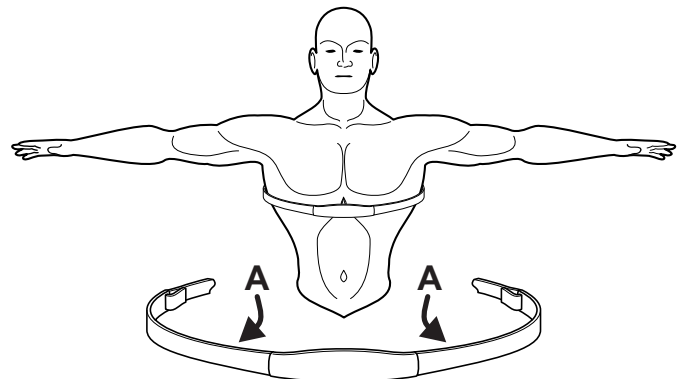



# 4 Workouts

## 4.1 Workout Overview

This section lists the Life Fitness Cross-Trainer's pre-programmed workouts. For more detailed information, see Section 4.2, *Using the Workouts*. The following workouts are accessible via the ARROW keys.

**QUICK START** is the fastest way to begin exercising. After the QUICK START key is pressed, a constant-level workout begins. The intensity level does not change automatically.

**MANUAL** is a constant effort workout in which the user can change the intensity level at any time.

**RANDOM** is an interval training workout of constantly changing intensity levels that occur in no regular pattern or progression.

**FAT BURN** is a low-intensity workout for burning a higher percentage of calories from fat. The user wears a Polar telemetry heart rate chest strap, or grasps the Lifepulse sensors continuously. The program adjusts the intensity level, based on the actual heart rate, to maintain the rate at 65 percent of the theoretical maximum.

**CARDIO** is a higher intensity workout for more fit users, maximizing cardiovascular benefits and total calories burned. The user wears a Polar telemetry heart rate chest strap, or grasps the Lifepulse sensors continuously. The program adjusts the intensity level, based on the actual heart rate, to maintain the rate at 80 percent of the theoretical maximum.

**HILL** is an interval training workout. Intervals are periods of intense aerobic exercise separated by regular periods of lower-intensity exercise.

**AROUND THE WORLD** is an interval-training workout in which the hills resemble scenes of various geographical areas.

**CASCADES** is a two-peak workout in which intensity levels gradually increase and decrease.

**FOOTHILLS** is a rolling hill workout with low intensity levels.

**INTERVAL** is a HILL workout in which intensity levels rise and fall. The higher levels gradually incline toward a peak and then gradually decline.

**KILIMANJARO** is a HILL workout in which the intensity levels gradually incline toward one ultimate peak and then gradually decline.

**SPEED TRAINING** is a HILL workout in which the intensity level alternates between high and low levels very quickly to simulate a typical speed training workout.

**HEART RATE HILL™** takes the user through three different hills based on the target heart rate. The user wears a Polar telemetry heart rate chest strap, or grasps the Lifepulse sensors continuously.

**HEART RATE INTERVAL™** alternates between a hill and a valley based on the target heart rate. The user wears a Polar telemetry heart rate chest strap, or grasps the Lifepulse sensors continuously.

**EXTREME HEART RATE™** is an intense workout for more experienced users. It is designed to get the heart rate up and down as quickly as possible. The user wears a Polar telemetry heart rate chest strap, or grasps the Lifepulse sensors continuously.

**LIFE FITNESS FIT TEST** estimates cardiovascular fitness and can be used to monitor improvements in endurance every 4-6 weeks.

**TOTAL BODY WORKOUT** simulates the experience of working with a personal trainer. The MESSAGE CENTER displays prompts at different times to emphasize pushing, pulling, total body, lower body, speed changes, and forward / reverse motion. This versatile workout promotes maximum cross-training benefits.

**LOWER BODY WORKOUT** continuously alternates five minutes of forward motion with two minutes of backward motion to cross-train different muscle groups.

**MY WORKOUTS** is not a workout program but a feature that allows the user to pre-set up to seven workouts with personal setup information, such as age or level, and then store the workouts in the console memory.

**SPORT TRAINING** simulates an outdoor terrain by setting various resistance levels.

**EZ RESISTANCE** features a gradual, subtle increase in resistance, independent of the user's pedaling speed. A peak in resistance is followed by an equally subtle decrease in resistance.

## 4.2 Using the Workouts

This section provides detailed information on setting up and using workouts. For quick-reference setup steps, see the chart at the end of the section.

### To Begin a Workout

To mount the Life Fitness Cross-Trainer, grasp the handles and carefully step on the pedals. To dismount, step off the pedals while still holding the handles. Then let go of the handles. Press START or simply begin pedaling to activate the console. The MESSAGE CENTER displays the prompt: "SELECT WORKOUT USING ARROW KEYS OR PRESS QUICK START". If it displays a different message, press the CLEAR key twice rapidly.

### Selecting and Using Quick Start

QUICK START is the fastest way to begin exercising and bypasses the steps of selecting a specific workout program. At the MESSAGE CENTER prompt to select a workout, press the QUICK START key. The workout begins at an intensity level that remains the same unless manually changed.

### Selecting a workout

For all workouts: When prompted to select a workout, use the ARROW KEYS or WORKOUT PROFILES key to scroll through the workout names as they appear in the MESSAGE CENTER. When the desired workout appears, press ENTER.

For MY WORKOUTS, once a workout is configured and saved, no further setup steps are necessary. For more information, see Section 4.4, *Using My Workouts Personal Programs*.

### Entering Weight

When prompted by the MESSAGE CENTER to enter weight, use the arrow keys to increase or decrease the displayed weight to the correct value and press ENTER. The default weight is 150 pounds or 68 kilograms. The on-board computer calculates the number and rate of calories burned using the entered weight as well as the pedaling speed and resistance level.

### Entering Age

When prompted by the MESSAGE CENTER to enter age, use the arrow keys to increase or decrease the displayed age to the correct value and press ENTER. Life Fitness Cross-Trainer workout programs that set a target heart rate zone first calculate the user's theoretical maximum heart rate. The HRmax equals 206.9 minus the total of 0.67 multiplied by a person's age. The programs then calculate the target zone as a percentage of the theoretical maximum.

### Entering Time

When prompted by the MESSAGE CENTER to enter a time, use the arrow keys to increase or decrease the displayed time to the desired value and press ENTER.

## Selecting and Adjusting the Resistance Level

When prompted by the MESSAGE CENTER, use the ARROW KEYS to increase or decrease the displayed resistance level or target heart rate to the desired value, and press ENTER. Adjust the level as needed or desired during the workout.

- **Resistance level:** The Life Fitness Cross-Trainer provides a selection of 25 resistance levels. The resistance level appears in the Workout Profile window as rows of lights arranged in columns. Selecting a low intensity level at first is recommended. As physical conditioning improves, the levels can increase.
- **Target heart rate:** Programs that calculate a target heart rate base this number on the age of the user and the type of workout. The user accepts or adjusts the rate when setting up the workout. During the workout itself, the program reads the heart rate, which is transmitted via the Lifepulse system sensors or the Polar heart rate chest strap; and it uses this data to adjust the resistance. Manually raising the rate increases the intensity of the cardiovascular exercise.

## Selecting a Workout Mode

Two workout mode options on the Life Fitness Cross-Trainer feature alternate ways to vary workouts.

- **Total Body Trainer:** This workout mode simulates the experience of working out with a trainer. Throughout the workout, the MESSAGE CENTER displays prompts to vary the workload and emphasize different muscle groups, such as upper- and lower-body. This feature can be used with any workout, except for FAT BURN, CARDIO, HEART RATE HILL, HEART RATE INTERVAL, EXTREME HEART RATE, and EZ RESISTANCE. To select it, press the TOTAL BODY TRAINER key.
- **Lower Body Trainer:** This workout mode continuously alternates five minutes of forward motion with two minutes of reverse motion, to exercise different leg muscles. This feature can be used with any workout, except for FAT BURN, CARDIO, HEART RATE HILL, HEART RATE INTERVAL, EXTREME HEART RATE, and EZ RESISTANCE. To select it, press the LOWER BODY TRAINER key.

## Switching Workouts “On-the-fly”

It is possible, during a workout, to switch to another workout program. After a switch, the console retains all the progress information about the workout since its beginning. To change workouts “on-the-fly,” press the WORKOUT PROFILES key, and then select a new workout. This feature is available for all workouts, except EZ RESISTANCE, AROUND THE WORLD, KILIMANJARO, INTERVAL, CASCADES, SPEED TRAINING, and FOOTHILLS.

## Ending Workouts Early

To end a workout before the pre-set duration expires, press CLEAR once. The MESSAGE CENTER then displays a workout summary, which includes the distance travelled, the total calories burned, and other statistics. Press CLEAR a second time and the MESSAGE CENTER displays “SELECT WORKOUT USING ARROW KEYS OR PRESS QUICK START” for a new workout.

## Pausing Workouts

To pause a workout, simply stop pedaling. To continue the workout, resume pedaling. The pause duration lasts 60 seconds, after which, the MESSAGE CENTER displays the prompt: “SELECT WORKOUT USING ARROW KEYS OR PRESS QUICK START”.

**NOTE:** In addition to stopping, users may also activate the PAUSE key once to pause workout data accumulation and pedal resistance. Press it again to resume workout.

**NOTE (INTERNATIONAL UNITS ONLY):** The Cross-Trainer will go into Energy Saving Mode after five minutes of inactivity. To wake up the console: start to pedal, press QUICK START, or select a workout.

The chart below lists the steps for setting up each workout. Use the ARROW KEYS or WORKOUT PROFILES key to scroll through the workout names as they appear in the MESSAGE CENTER. When the desired workout appears, press ENTER.

### **Quick Start**

Press QUICK START  
Begin workout

### **Manual**

Select MANUAL  
Enter Weight  
Enter Time  
Select Level  
Begin Workout

### **Random**

Select RANDOM  
Enter Weight  
Enter Time  
Select Level  
Begin Workout

### **Fat Burn**

Select FAT BURN  
Enter Weight  
Enter Time  
Enter Age  
Accept Target Heart Rate  
Begin Workout

### **Cardio**

Select CARDIO  
Enter Weight  
Enter Time  
Enter Age  
Accept Target Heart Rate  
Begin Workout

### **Hill**

Select HILL  
Enter Weight  
Enter Time  
Select Level  
Begin Workout

### **Heart Rate Hill**

Select HEART RATE HILL  
Enter Weight  
Enter Time  
Enter Age  
Accept Target Heart Rate  
Begin Workout

### **Interval**

Select INTERVAL  
Enter Weight  
Enter Time  
Select Level  
Begin Workout

### **Heart Rate Interval™**

Select HEART RATE INTERVAL  
Enter Weight  
Enter Time  
Enter Age  
Accept Target Heart Rate  
Begin Workout

### **Extreme Heart Rate™**

Select EXTREME HEART RATE  
Enter Weight  
Enter Time  
Enter Age  
Accept Target Heart Rate  
Begin workout

### **Life Fitness Fit Test**

Select FIT TEST  
Enter Weight  
Enter Age  
Enter Gender  
Select Level  
Begin Workout

### **Around the World**

Select AROUND THE WORLD  
Enter Weight  
Enter Time  
Select Level  
Begin Workout

### **Cascades**

Select CASCADES  
Enter Weight  
Enter Time  
Select Level  
Begin Workout

### **Foothills**

Select FOOTHILLS  
Enter Weight  
Enter Time  
Select Level  
Begin Workout

### **Kilimanjaro**

Select KILIMANJARO  
Enter Weight  
Enter Time  
Select Level  
Begin Workout

### **Speed Training**

Select SPEED TRAINING  
Enter Weight  
Enter Time  
Select Level  
Begin Workout

### **Lower Body Workout**

Select LOWER BODY WORKOUT  
Enter Weight  
Enter Time  
Select Level  
Begin Workout

### **Total Body Workout**

Select TOTAL BODY WORKOUT  
Enter Weight  
Enter Time  
Select Level  
Begin Workout

### **Sport Training**

Select SPORT TRAINING  
Enter Weight  
Select Time  
Select Level  
Begin Workout

### **EZ Resistance**

Select EZ RESISTANCE  
Enter Weight  
Select Time  
Select Level  
Begin Workout

## 4.3 Workout Descriptions

**QUICK START** is the fastest way to begin exercising and bypasses the steps of selecting a specific workout program. The intensity level for the workout is set automatically to Level 1 and remains the same unless manually changed. To change the level, use the UP and DOWN ARROW keys to enter a higher or lower level number.

### MANUAL

The MANUAL program sets an intensity level that does not change automatically. While the workout is in progress, increase or lower the intensity level as desired using the ARROW keys.

### RANDOM

The RANDOM program creates a terrain of hills and valleys that varies with each workout. More than one million different patterns are possible.

### FAT BURN

The FAT BURN workout is designed to maintain a user's heart rate at 65% of the theoretical maximum (HRmax) for optimal results. Throughout the workout, the user wears a Polar telemetry heart rate chest strap or grasps the Lifepulse sensors. If the user is not wearing a Polar telemetry heart rate chest strap, the WORKOUT PROFILE WINDOW displays a heart shape, and the MESSAGE CENTER displays a prompt to grasp the sensors. The console continuously monitors and displays the heart rate, adjusting the intensity level of the cross-trainer to reach and maintain the target. This system eliminates over-training and under-training, and it maximizes the aerobic benefits of exercise by using the body's fat stores for fuel.

### CARDIO

The CARDIO workout is virtually identical to Fat Burn, however the target heart rate is calculated at 80% of the theoretical maximum (HRmax). The higher target promotes cardiovascular improvement by placing a heavier workload on the heart muscle.

### SPORT TRAINING™ WORKOUT

This workout sets different hills, or resistance levels, throughout the course. Each hill matches a progressive degree of difficulty. Hills last between 30 and 60 seconds, depending on the workout duration.

### EZ RESISTANCE

In this workout, the gradual changes in resistance are extremely subtle, lowering perceived exertion. The changes in resistance also are independent of user's pedaling speed. The cardiovascular workout is effective, efficient, and enjoyable at the same time.

The workout consists of one hill. The user determines the height of the peak of this hill by selecting an intensity level during the setup. The higher the level selected, the higher the intensity at the entry point, which is the beginning of the workout, and the higher the intensity at the peak, which occurs after 75% of the workout is completed. After the peak is reached, the resistance gradually returns to the same intensity level as that of the entry point. See the chart below.

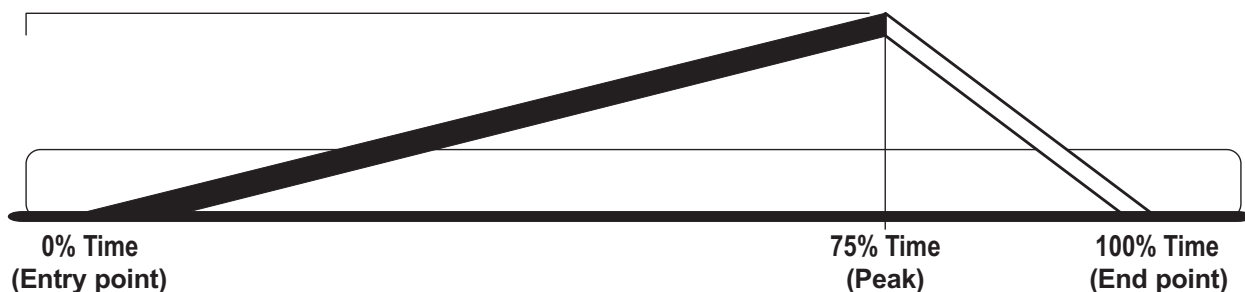

**EZ Resistance Workout Profile**

## HILL

The Life Fitness-patented HILL workout offers a variety of configurations for interval training. Intervals are periods of intense cardiovascular exercise separated by regular periods of lower-intensity exercise. The WORKOUT PROFILE window represents these high and low intervals as columns of illuminated LEDs, which together have the appearance of hills and valleys. The computerized interval training workout has been scientifically demonstrated to promote greater cardiorespiratory improvement than steady-pace training.

The HILL workout goes through four phases, each marked by different intensity levels. The WORKOUT PROFILE window displays the progress of these phases. As noted in the descriptions below, the heart rate should be measured at two stages in the workout to gauge its effectiveness. Wear the Polar telemetry heart rate chest strap or continuously grip the Lifepulse handles. The MESSAGE CENTER does not display a request for a heart rate measurement, as it does with CARDIO, FAT BURN and the HEART RATE ZONE TRAINING programs.

1. **Warm-up** is a phase of low, gradually rising resistance, which brings the heart rate into the lower end of the target zone and increases respiration and blood flow to working muscles.
2. **Plateau** increases the intensity slightly and keeps it steady, to bring the heart rate to the low end of the target zone. Check the heart rate at the end of this phase.
3. **Interval Training** is a series of increasingly steeper hills alternating with valleys or stints of recovery. The heart rate should rise to the high end of the target zone. Check the heart rate at the end of this phase.
4. **Cool Down** is a low-intensity phase that allows the body to begin removing lactic acid and other exercise by-products which build up in muscles and contribute to soreness.

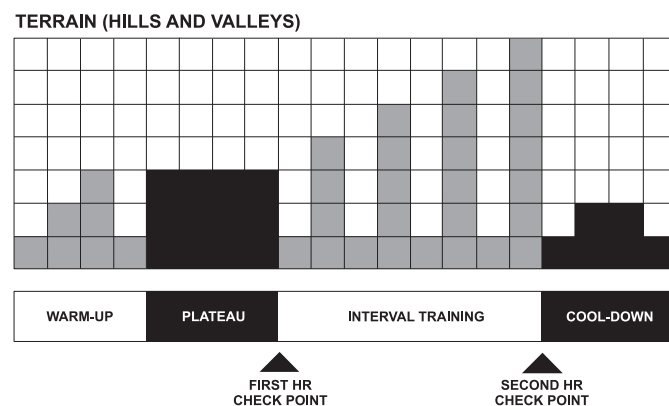

Each column, as seen in the WORKOUT PROFILE WINDOW and the chart above, represents one interval. The overall duration of the workout determines the length of each interval. Each workout is made up of 20 intervals, so the duration of each interval is equal to the duration of the entire workout divided by 20.

**1 to 9 minutes:** A workout with a duration of less than 10 minutes is insufficient for the HILL program to complete all four phases adequately. The program therefore condenses a workout of this duration at various stages.

**10 to 19 minutes:** The interval durations initially are set at 30 seconds for a 10-minute workout. For every minute over 10, each interval increases by three seconds. A 15-minute workout consists of 20 intervals at 45 seconds each.

**20 to 99 minutes:** All intervals last 60 seconds. If the user adds minutes to the pre-set duration while the workout is in progress, the program adds hills and valleys that are identical to the first eight intervals of the Interval Training phase. This pattern repeats until the workout is completed.

## HEART RATE HILL™

This program combines the standard HILL workout profile with the concept of Heart Rate Zone Training. The default target heart rate is calculated as 80% of the theoretical maximum (HRmax), but the user can adjust the target rate during the workout setup. All hills and valleys are percentages of HRmax. The workout consists of three hills that target three heart rate goals: The first hill brings the heart rate to 70% of HRmax. The second hill increases the rate to 75% of HRmax. The third hill matches the Target Heart Rate bringing the heart rate to 80% of HRmax. The valley always is defined as 65 percent of HRmax.

After a standard three-minute warm-up, the workout progresses toward the first hill and heart rate goal. Once the user reaches 70% of HRmax, the hill continues for one minute. When the minute expires, the level decreases into a valley. Once the user's heart rate falls to 65% of HRmax, the valley continues for one minute. Then, the next hill begins with its corresponding heart rate goal. After the user completes the third hill/valley pair, the program returns to the first hill and repeats the cycle as long as the duration allows. At the end of the duration, the workout goes into a cool-down phase. If the heart rate goes above the theoretical maximum for more than 45 seconds, the cross-trainer automatically goes into pause mode. The program does not proceed to a new heart rate goal until the user reaches the current goal.

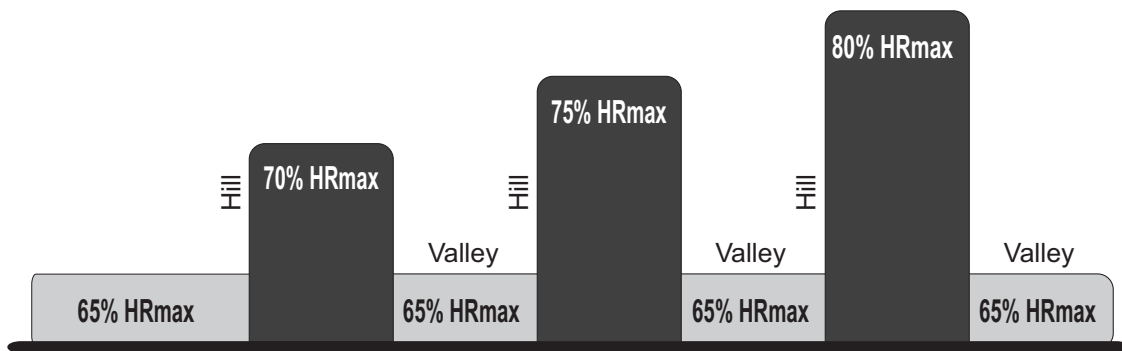

HEART RATE HILL Workout Profile

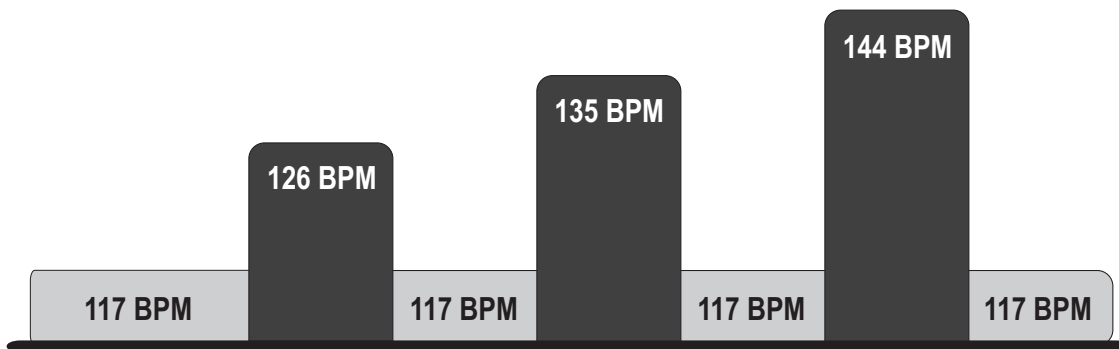

User Example: 80 percent of theoretical maximum (HRmax) (40 year old / 144 recommended BPM)

## HEART RATE INTERVAL™

This program also combines the standard HILL workout profile with the concept of Heart Rate Zone Training. The default target heart rate is calculated as 80% of the theoretical maximum (HRmax), but the user can adjust the target rate during the workout setup. The workout alternates between a hill, which brings the heart rate up to the target rate of 80% of HRmax, and a valley which brings the heart rate down to 65% of HRmax. After a standard three-minute warm-up, the workout progresses toward the first hill and heart rate goal. Once the goal is reached, the hill continues for three minutes, then the level decreases into a valley. Once the 65% of HRmax goal is reached, the valley continues for three minutes, after which the next hill begins. The user's fitness level determines the number of hills and valleys encountered within the duration. At the end of the duration, the workout goes into a cool down phase. If the heart rate goes above the theoretical maximum for more than 45 seconds, the cross-trainer automatically goes into pause mode. The program does not proceed to a new heart rate goal until the user reaches the current goal.

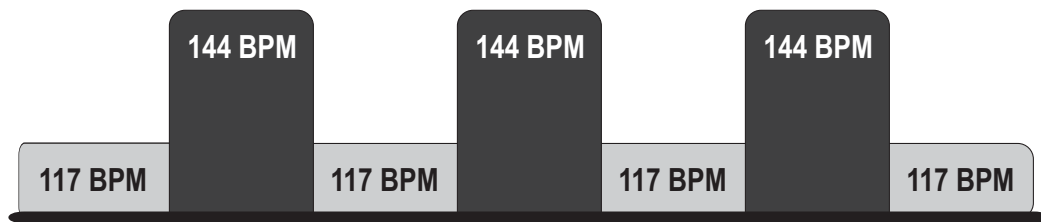
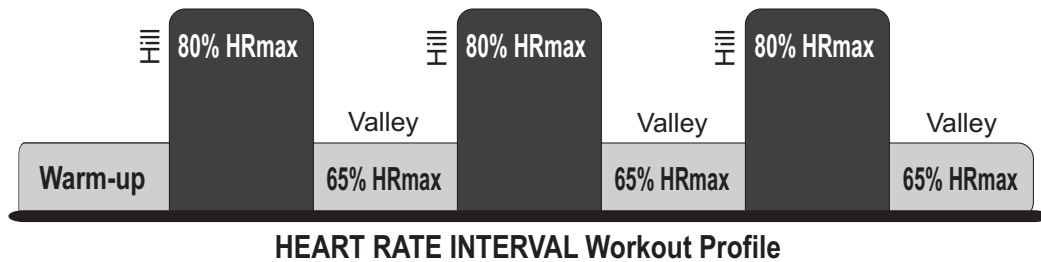

**User Example: 80 percent of theoretical maximum (HRmax) (40 year old / 144 recommended BF)**



## EXTREME HEART RATE™

This intense, varied workout is designed to help more experienced users to break through fitness improvement plateaus. The workout alternates between two target heart rates as quickly as possible. The effect is similar to that of running sprints. The user must wear a Polar telemetry heart rate chest strap or grip the Lifepulse sensors throughout the workout.

When setting up the workout, the user enters a target heart rate. After a standard three-minute warm-up, the intensity increases until the user reaches the target heart rate goal of 85% of the theoretical maximum (HRmax). That target rate is maintained for a stabilizing period. Then, the intensity decreases. When the heart rate falls to the 65% of HRmax goal, it is maintained there for a stabilizing period. The program repeats the alternating intensity levels, continuing this pattern throughout the duration.

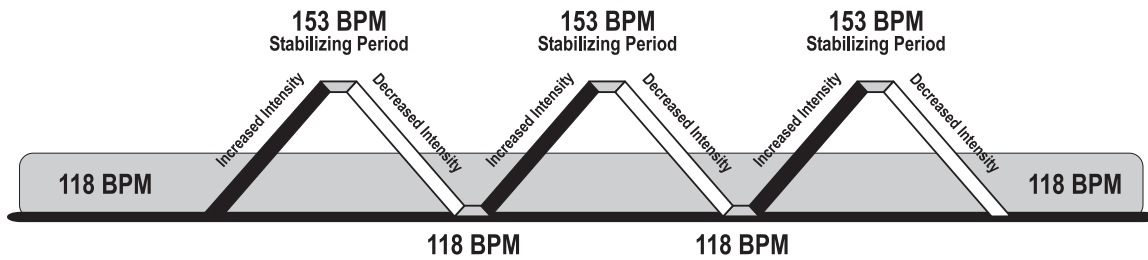
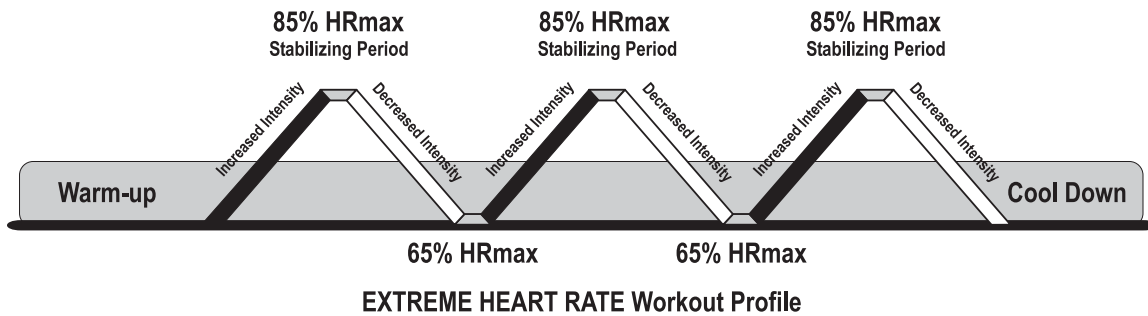

## SIX PRE-SET WORKOUTS

AROUND THE WORLD, CASCADES, FOOTHILLS, INTERVAL, KILIMANJARO, and SPEED TRAINING are variations of the HILL workout. These workouts cannot be changed "on the fly."

- AROUND THE WORLD is an interval-training workout in which the hills resemble scenes of various geographical areas.
- CASCADES is a two-peak workout in which intensity levels gradually increase and decrease.
- FOOTHILLS is a rolling hill workout with low intensity levels.
- INTERVAL is a Hill workout in which intensity levels rise and fall. The higher levels gradually incline toward a peak and then gradually decline.
- KILIMANJARO is a Hill workout in which the intensity levels gradually incline toward one ultimate peak and then gradually decline.
- SPEED TRAINING is a Hill workout in which the intensity level alternates between high and low levels very quickly to simulate a typical speed training workout.

## TOTAL BODY WORKOUT

During this workout, the MESSAGE CENTER displays prompts to emphasize different muscle groups. To emphasize upper-body muscles, the MESSAGE CENTER displays prompts to focus on pushing and pulling the moving arms at various times. To emphasize lower-body muscles, the MESSAGE CENTER displays prompts to rest the hands on the stationary handlebar, thus forcing the legs to do all the work. The program also alternates between forward and reverse motion as well as different speeds.

Ten seconds after prompting the user to change pedaling direction, the workout applies "braking resistance," that is, a high resistance level that essentially forces the user to stop pedaling. Once the user stops pedaling, the workout resumes the normal resistance level. The actual level of braking resistance depends on the user's pedaling RPM. If the user is pedaling at a rate equal to, or faster than, 65 RPM, the workout applies the maximum level of braking resistance. If the user is pedaling at a speed below 65 RPM, the workout applies 92% of the maximum.

TOTAL BODY WORKOUT is a constant-resistance workout. However, for a similar experience with a variable-resistance-level workout, the user can start any workout, except for FAT BURN, CARDIO, HEART RATE HILL, HEART RATE INTERVAL, EXTREME HEART RATE, or EZ RESISTANCE; and then press the TOTAL BODY TRAINER key.

## LOWER BODY WORKOUT

During this workout, the MESSAGE CENTER displays alternating prompts to use pedal forward for five minutes and then backward motion for two minutes. This feature varies the emphasis on different leg muscles. Ten seconds after prompting the user to change pedaling direction, the workout applies "braking resistance," that is, a high resistance level that essentially forces the user to stop pedaling. Once the user stops pedaling, the workout resumes the normal resistance level. The actual level of braking resistance depends on the user's pedaling RPM. If the user is pedaling at a rate equal to, or faster than, 65 RPM, the workout applies the maximum level of braking resistance. If the user is pedaling at a speed below 65 RPM, the workout applies 92% of the maximum.

LOWER BODY WORKOUT is a constant-resistance workout. However, for a similar experience with a variable-resistance-level workout, the user can start any workout, except for FAT BURN, CARDIO, HEART RATE HILL, HEART RATE INTERVAL, EXTREME HEART RATE, or EZ RESISTANCE; and then press the LOWER BODY TRAINER key.

## FIT TEST

The Life Fitness Cross-Trainer Fit Test program is another exclusive feature of this versatile Cross-Trainer. The Fit Test workout estimates cardiovascular fitness and can be used to monitor improvements in endurance every four to six weeks. The user must grasp the Lifepulse hand sensors when prompted or wear a heart rate chest strap, as the test score calculation is based on a heart rate reading. The workout duration will be five minutes at the chosen resistance level. Immediately afterward, the console will take the user's heart rate reading, calculate a fitness score, and display the score in the MESSAGE CENTER.

The Fit Test is considered to be a submax  $VO_2$  (volume of oxygen) test. It gauges how well the heart supplies oxygenated blood to the exercising muscles, and how efficiently those muscles receive oxygen from the blood. Physicians and exercise physiologists generally regard this test as a good measure of aerobic capacity.

To set up the Fit Test:

- Begin pedaling.
- Press the WORKOUT PROFILES button repeatedly until the FIT TEST option appears in the MESSAGE CENTER. Press ENTER to select the FIT TEST option.
- The MESSAGE CENTER will prompt for a user weight (ENTER WEIGHT). Use the NUMERIC KEYS or UP/DOWN ARROW KEYS to input your weight. Press ENTER to accept the weight.
- The MESSAGE CENTER will next prompt for a user age (ENTER AGE). Use the NUMERIC KEYS or UP/DOWN ARROW KEYS to input your age. Press ENTER to accept the age.
- The MESSAGE CENTER will next prompt for a user gender (SELECT GENDER). Using the UP/DOWN ARROW KEYS, select a gender. Press ENTER to accept the gender selection.
- The MESSAGE CENTER will next prompt for a workout level (ENTER LEVEL). Consult the following recommended fit test level chart for an appropriate effort level based on your age, gender and activity level. Use the NUMERIC KEYS or UP/DOWN ARROW KEYS to enter the corresponding level.
- As the test continues, a message will prompt the user to maintain a pedaling rate between 50-60 rpm (equivalent to 4.2-5.5 mph). The user must maintain this rate throughout the 5-minute test duration. After 16 seconds, if 50-60 rpm is not maintained, the fit test will automatically terminate.

After the five-minute FIT TEST is completed, a FIT TEST score will be displayed.

### Fit Test Program Suggested Exertion Levels

	<b>Inactive</b>	<b>Active</b>	<b>Very Active</b>
Cross-Trainer Fit Test Level	L 2-4 men	L 3-10 men	L 7-15 men
	L 1-2 women	L 2-5 women	L 3-10 women

Suggested exertion levels should be used as a guideline for setting up the Fit Test program. The goal is to elevate the user's heart rate to a level that is between 60%-85% of their theoretical maximum heart rate.

Within each suggested range, these additional guidelines can be used:

<b>Lower Half of Range</b>	<b>Upper Half of Range</b>
higher age	lower age
lower weight	higher weight*
shorter	taller

\* In cases of excessive weight, use lower half of range

The computer will not accept:

- heart rates less than 52 or greater than 200 beats per minute
- body weights less than 75 pounds (34 kg) or greater than 400 pounds (181 kg)
- ages below 10 or over 99 years
- data input that exceeds human potential

If you make an error when entering any Fit Test data, you can correct it by pressing CLEAR, inputting the correct information, and pressing ENTER.

It is important for you to take the Fit Test under similar circumstances each time. Your heart rate is dependent on many factors, including:

- amount of sleep the previous night (at least seven hours is recommended)
- time of day
- time you last ate (two to four hours after the last meal is recommended)
- time since you last drank a liquid containing caffeine or alcohol, or smoked a cigarette (at least four hours is recommended)
- time since you last exercised (at least six hours is recommended)

For the most accurate Fit Test results, you should perform the Fit Test on three consecutive days and average the three scores.

**NOTE:** To receive a proper Fit Test score, the work done must be within a training heart rate zone that is 60% to 85% of the theoretical maximum heart rate (HRmax). This program requires a constant exertion for accuracy, so it will not be allowed to resume if paused. This program will control level. Manual adjustment of level is not permitted.

The tables below list fit test results.

#### Relative Fitness Classification for MEN

Rating	<i>Elite</i>	<i>Excellent</i>	<i>Very Good</i>	<i>Above Average</i>	<i>Average</i>	<i>Below Average</i>	<i>Low</i>	<i>Very Low</i>
<b>Estimated VO<sub>2</sub> Max (ml/kg/min) per Age category</b>								
20 - 29 years	55+	53 - 54	50 - 52	45 - 49	40 - 44	38 - 39	35 - 37	<35
30 - 39 years	52+	50 - 51	48 - 49	43 - 47	38 - 42	36 - 37	34 - 35	<34
40 - 49 years	51+	49 - 50	46 - 48	42 - 45	37 - 41	34 - 36	32 - 33	<32
50 - 59 years	47+	45 - 46	43 - 44	39 - 42	34 - 38	32 - 33	29 - 31	<29
60+ years	43+	41 - 42	39 - 40	35 - 38	31 - 34	29 - 30	26 - 28	<26

#### Relative Fitness Classification for WOMEN

Rating	<i>Elite</i>	<i>Excellent</i>	<i>Very Good</i>	<i>Above Average</i>	<i>Average</i>	<i>Below Average</i>	<i>Low</i>	<i>Very Low</i>
<b>Estimated VO<sub>2</sub> Max (ml/kg/min) per Age category</b>								
20 - 29 years	47+	45 - 46	43 - 44	38 - 42	33 - 37	31 - 32	28 - 30	<28
30 - 39 years	44+	42 - 43	40 - 41	36 - 39	31 - 35	29 - 30	27 - 28	<27
40 - 49 years	42+	40 - 41	38 - 39	34 - 37	30 - 33	28 - 29	25 - 27	<25
50 - 59 years	37+	35 - 36	33 - 34	30 - 32	26 - 29	24 - 25	22 - 23	<22
60+ years	35+	33 - 34	31 - 32	27 - 30	24 - 26	22 - 23	20 - 21	<20

Life Fitness developed this rating scale based on VO<sub>2</sub> max percentile distributions referenced in *American College of Sports Medicine's Guidelines for Exercise Testing and Prescription* (8th E. 2010). It is designed to provide a qualitative description of a user's VO<sub>2</sub> max estimation, and a means of assessing initial fitness level and tracking improvement.

## 4.4 Using My Workouts Personal Programs

The MY WORKOUTS personal programs feature on the Life Fitness Cross-Trainer makes it possible to pre-set up to seven workouts with personal setup information, such as age or duration, and then store the workouts in the console memory. MY WORKOUTS is used to store statistics for up to 7 different users or profiles. These workouts are accessed with the MY WORKOUTS key.

MY WORKOUTS allows the end-user to customize the set-up of a workout once and save it for quick start up. Any of the following workouts may be pre-set and stored: FAT BURN, CARDIO, HEART RATE HILL, HEART RATE INTERVAL, EXTREME HEART RATE, HILL, RANDOM, MANUAL, SPORT TRAINING, and EZ RESISTANCE. MY WORKOUTS allows the end-user to view workout statistics overtime applicable to each saved profile.

### My Workouts - Programming Options

Press the MY WORKOUTS key. Press the MY WORKOUTS key again to scroll through MY WORKOUTS. Press ENTER to select and start a MY WORKOUT. Press and hold the MY WORKOUTS key on the desired MY WORKOUT for editing options (this will only edit the selected MY WORKOUT). Press ENTER on one of the editing options: CHANGE NAME, CHANGE WORKOUT, or VIEW STATISTICS.

Programmed Options	Description
NAME	Name of the user or profile, up to 16 characters
WORKOUT NAME	Choose a workout profile (ie. Random)
TIME	Duration of workout in minutes
WEIGHT	Weight of user in pounds or kilograms
AGE	Age of user in years
THR or LEVEL	Target Heart Rate for HeartSync™ workouts and resistance level for other profiles.

### My Workouts - Programming the Name (Change Name)

Press the MY WORKOUTS key to scroll through all My Workouts. The default My Workouts names will be MY WORKOUT 1 through MY WORKOUT 7. Once the desired MY WORKOUT appears, press and hold the MY WORKOUTS key for editing options. The message center then displays USE ARROW KEYS TO SCROLL AND ENTER KEY TO SELECT EDIT OPTIONS. Scroll through the edit options by using the ARROW KEYS and press the ENTER key when CHANGE NAME appears. A name will appear with the first character blinking. To modify the first character simply press the UP or DOWN ARROW keys to scroll through all available characters. Once the desired character appears press the ENTER key to accept the character and then automatically move to the next character. When completed, press and hold the MY WORKOUTS key to save the profile name. The name will be saved and the display will return to EDIT OPTIONS. The PAUSE/CLEAR key can be pressed at anytime to delete the current flashing character. In addition, when the first character is blinking the PAUSE/CLEAR key can be pressed to return the console to My Workouts EDIT OPTIONS. If the PAUSE/CLEAR key is pressed while in My Workouts EDIT OPTIONS the console will return to idle mode. If no key is pressed within 30 seconds, the display will exit the programming mode and return to idle mode. No workout will be saved.

### My Workouts - Programming the Workout Profile (Change Workout)

Press the MY WORKOUTS key to scroll through all My Workouts. The default My Workouts names will be MY WORKOUT 1 through MY WORKOUT 7. Once the desired MY WORKOUT appears, press and hold the MY WORKOUTS key for editing options. The message center then displays USE ARROW KEYS TO SCROLL AND ENTER KEY TO SELECT EDIT OPTIONS. Scroll through the edit options by using the ARROW KEYS and press the ENTER key when CHANGE WORKOUT is displayed. The console will seem like it is now in normal workout set-up mode. Choose a workout and press the ENTER key. Set all other workout parameters such as time, weight, age, or target heart rate / level. If no key is pressed within 30 seconds, the display will exit the programming mode and return to idle mode. No workout will be saved.

### My Workouts - Viewing the Statistics (View Statistics)

Press the MY WORKOUTS key to scroll through all My Workouts. The default My Workouts names will be MY WORKOUT 1 through MY WORKOUT 7. Once the desired MY WORKOUT appears, press and hold the MY WORKOUTS key for editing options. The message center then displays USE ARROW KEYS TO SCROLL AND ENTER KEY TO SELECT EDIT OPTIONS. Scroll through the edit options by using the ARROW KEYS and press the ENTER key when VIEW STATISTICS is displayed. Press the ARROW KEYS to scroll through statistics including: Accumulated Time (hours), Accumulated Minutes (minutes combined with hours), Accumulated Calories, and Accumulated Distance. Press the MY WORKOUTS key at any time to exit statistics and return to My Workouts EDIT OPTIONS. If no key is pressed within 30 seconds, the display will exit the programming mode and return to idle mode. No workout will be saved.

# 5 System Menu (Optional Settings)

A special system menu is available to Managers and other authorized personnel to allow access to certain information, diagnostics tests and configuration settings.

## 5.1 Entering and Using the System Menu

The System Menu consists of 3 submenus including the Information submenu, Diagnostic submenu and Configuration submenu.

### ENTERING SYSTEM MENU

Press and hold down the UP ARROW key and then press the CLEAR key twice. Continue to hold down the UP ARROW key until the MESSAGE CENTER displays the words CODE VER. X.XX. This is the Information menu which is the default submenu in the Service Menu.

### System Menu Overview

#### Information Menu (CODE VER X.XX)

The Information submenu will display information identifying the software version numbers and their associated part numbers as well as the version numbers of other installed software components. Use this menu when it is necessary to identify the version/part numbers installed on the product. The UP and DOWN ARROW keys can be used to navigate through the list of items that may be displayed. Press the CLEAR key once to exit the Information Menu.

#### Diagnostics Menu (SERVICE MENU)

The Diagnostics submenu allows technicians to run system diagnostics. This menu can be entered from the Information Menu by pressing and holding the COOL DOWN key then pressing the ENTER key. The MESSAGE CENTER will display the words SERVICE MENU. Pressing the ENTER key will navigate forward through the list of diagnostic utilities while pressing the CLEAR key will navigate backward. Use the CLEAR key repeatedly to exit the Diagnostics Menu.

#### Configuration Menu (OPTIONAL SETTINGS)

The Configuration submenu allows the manager to configure options for the product. This menu can be entered from the Information Menu by pressing the ENTER key. The MESSAGE CENTER will display the words OPTIONAL SETTINGS. Pressing the ENTER key will navigate forward through the list of optional settings while pressing the CLEAR key will navigate backward. Use the CLEAR key repeatedly to exit the Configuration Menu. See the next page for a list of configuration options (Optional Settings).

## 5.2 Manager's Configuration (Optional Settings)

Setting	Default	Description
Maximum Workout Duration	60 Minutes	This feature allows the setting of maximum workout duration limits.
English / Metric Units	English (International: Metric)	This option sets the measurement unit type for weight, distance, and speed.
Pause Timeout	5 Minutes	This sets the maximum time during which a workout can remain in pause mode.
WATTS Display	Off (International: On)	If this option is enabled, the MESSAGE CENTER displays the Watts equivalent of the step rate.
METS Display	Off	If this option is enabled, the MESSAGE CENTER displays the METs equivalent of the step rate.
Calorie Per Hour (CPH) Display	On (International: Off)	If this option is enabled, the MESSAGE CENTER displays the number of calories burned per hour during the workout.
Sleep Mode	Off	The Sleep Time configuration setting controls how long the console will stay powered up from the last key press but before actively engaging the product in exercise. This configuration applies to externally powered products only. Upon entry to this utility the current configuration setting shall be displayed. The UP / DOWN arrow keys shall allow incrementing/ decrementing of the Sleep Time value in 1 minute increments respectively. The range of values for Sleep Time shall be 1 through 99 minutes and OFF.
Language Select	Off	If this option is enabled, users can set the User Language. Choices include: English, German, French, Spanish, Italian, Dutch, and Russian.
iPod Video	Enable	This feature allows control over allowing iPod video tracks to be played on the Life Fitness Attachable TV, if present. If enabled by selecting the ON setting, and an iPod video track is selected, the video shall be routed to the TV. Otherwise, the video shall not.
AUX Source	Off	This setting allows control over whether or not an optional CSAFE compatible audio device attached to the CSAFE connector shall be selectable as an audio source with the SOURCE SELECT key.
TV GAIN	2	This setting allows control over the console earphone volume range for the Life Fitness Attachable TV Source. The range of settings are from 0 (Low) to 7 (High).

## User Language Select

If enabled, this option allows users to select the language by which to interact with the unit during a workout.

**To use the option**, enable User Language Select (see below).

Begin pedaling. The console will display the message "SELECT LANGUAGE USING ARROW KEYS". The user can select from a list of available languages using any of the arrow keys. Press ENTER when the desired language appears to select that language. A workout can now be started using the selected language. Selecting a language is not necessary to begin a workout. Simply press the QUICK START key to start a workout or any of the program keys to begin workout programming using the default language.

The user may select from the following languages: English, German, French, Italian, Dutch, Spanish, and Russian.

To enable the User Language Select option, enter the Optional Settings (see Section 5.1). Scroll forward through the options using the ENTER key, or backward, using the CLEAR key until LANGUAGE SEL appears. Once LANGUAGE SEL appears in the Message Center, press any of the UP/DOWN ARROW keys to toggle the mode from OFF to ON.



# 6 Service and Technical Data

## 6.1 Preventive Maintenance Tips

Life Fitness products are backed by the engineering excellence and reliability of Life Fitness and are one of the most rugged and trouble-free pieces of exercise equipment on the market today.

**NOTE:** *Safety of the equipment can be maintained only if the equipment is examined regularly for damage or wear. Keep the equipment out of use until defective parts are repaired or replaced. Pay special attention to parts that are subject to wear, as outlined below.*

**REMARQUE:** *pour conserver un matériel sûr, il convient de l'inspecter régulièrement afin de déceler tout signe d'usure ou d'endommagement. N'utilisez pas l'appareil tant que les pièces défectueuses n'ont pas été réparées ou remplacées. Portez une attention toute particulière aux pièces qui s'usent, comme indiqué ci-dessous.*

The following preventive maintenance tips will keep the Life Fitness product operating at peak performance:

- Locate the Life Fitness Cross-Trainer in a cool, dry place.
- Clean the top surface of the pedals regularly.
- Keep the display console free of fingerprints and salt build-up caused by sweat.
- Clean the display console and all exterior surfaces with an approved or compatible cleaner (see *Life Fitness Approved Cleaners*) and a soft cotton cloth.
- Long fingernails may damage or scratch the surface of the console; use the pad of the finger to press the selection buttons on the console.
- Clean the housing and moving arms thoroughly on a regular basis.

### Life Fitness Approved Cleaners (United States Availability Only)

Two preferred cleaners have been approved by Life Fitness reliability experts: PureGreen 24 and Gym Wipes. Both cleaners will safely and effectively remove dirt, grime and sweat from equipment. PureGreen 24 and the Antibacterial Force formula of Gym Wipes are both disinfectants that are effective against MRSA and H1N1. PureGreen 24 is available in a spray which is convenient for gym staff to use. Apply the spray to a microfiber cloth and wipe down the equipment. Use PureGreen 24 on the equipment for at least 2 minutes for general disinfection purposes and at least 10 minutes for fungus and viral control. Gym Wipes are large, durable pre-moistened wipes to use on the equipment before and after workouts. Use Gym Wipes on the equipment for at least 2 minutes for general disinfection purposes.

Contact Customer Support Services to order these cleaners (1-800-351-3737 or email: [customersupport@lifefitness.com](mailto:customersupport@lifefitness.com)).

### Life Fitness Compatible Cleaners

Mild soap and water or a mild non-abrasive household cleaner can also be used to clean the display and all exterior surfaces. Use a soft microfiber cloth only. Apply the cleaner to the microfiber cloth before cleaning. DO NOT use ammonia or acid based cleaners. DO NOT use abrasive cleaners. DO NOT use paper towels. DO NOT apply cleaners directly to the equipment surfaces.

## 6.2 Preventive Maintenance Schedule

<b>Item</b>	<b>Weekly</b>	<b>Monthly</b>	<b>Biannually</b>
<i>Console Overlay</i>	Clean		Inspect
<i>Accessory Trays</i>	Clean	Inspect	
<i>Frame</i>	Clean		Inspect
<i>Plastic Covers</i>	Clean	Inspect	
<i>Lifepulse Sensors</i>	Clean / Inspect		

## 6.3 Troubleshooting the Optional Polar Telemetry Heart Rate Chest Strap

Malfunction	Probable Cause	Corrective Action
Heart rate reading is initially detected and functioning normally but then is lost.	Use of personal electronic devices, such as cell phones and portable MP3 players, causes external noise interference.	Remove the source of noise or reposition the exercise equipment.
	Equipment is in close proximity to other sources of noise such as audio/ video equipment, fans, two way radios, and high voltage/high current power lines.	
Heart rate readings are abnormally elevated.	Television sets and/or antennas generate electromagnetic interference.	Move the cross-trainer a few inches away from the probable cause, or move the probable cause a few inches away from the cross-trainer until the heart rate readings are accurate.
	Cell phones generate electromagnetic interference.	
	Computers generate electromagnetic interference.	
	Cars generate electromagnetic interference.	
	High voltage power lines generate electromagnetic interference.	
	Motor driven exercise equipment generates electromagnetic interference.	
	Another heart rate transmitter within 3 feet (1 meter) generates electromagnetic interference.	
Heart rate reading is erratic or absent entirely.	Belt transmitter electrodes are not wet enough to pick up accurate heart rate readings.	Wet the belt transmitter electrodes (see Section 3.2).
	Belt transmitter electrodes are not laying flat against the skin.	Ensure the belt transmitter electrodes are laying flat against the skin (see Section 3.2).
	Belt transmitter needs cleaning.	Wash the belt transmitter with mild soap and water.
	Belt transmitter is not within 3 feet (1 meter) of the heart rate receiver.	Make sure the chest strap transmitter is within 3 feet (1 meter) of the heart rate receiver.
	Polar telemetry heart rate chest strap battery is depleted.	Contact Life Fitness Customer Support Services for instruction on how to have the Polar telemetry heart rate chest strap replaced.
	Polar telemetry heart rate chest strap did not lock in with the heart rate receiver.	Make sure the Polar telemetry heart rate chest strap is applied and move closer to the heart rate receiver. Wait up to 10 seconds for the heart rate to display on the console.  NOTES: 1. Ensure proper adherence of the Polar telemetry heart rate chest strap to user's chest. 2. Ensure proper conductivity between the electrodes and user's chest. 3. If needed, use the Polar watch to verify chest strap's operation.

## 6.4 Troubleshooting the Lifepulse System Sensors

If the heart rate reading is erratic or missing, do the following:

- Dry hands if necessary to prevent slipping.
- Apply hands to all four sensors; two in each hand.
- Grasp the sensors firmly.
- Apply constant pressure around the sensors.

## 6.5 How to Obtain Product Service / Serial Number Location

1. Verify the symptom and review the operating instructions. The problem may be unfamiliarity with the product and its features and workouts.
2. Locate and write down the serial number of the unit which is located on the front stabilizer.
3. Contact Life Fitness Customer Support Services.

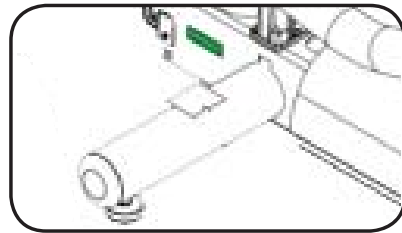
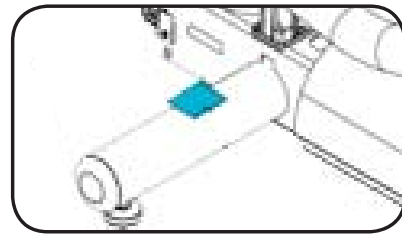

**Remove plastic shroud to find the small serial label location.**

# 7 Specifications

Designed use:	Consumer
Maximum user weight:	350 pounds / 160 kilograms
Power requirements:	120 volt, 1.0 amp (U.S. & Canada); 100-240 volt, 1.0 amp (outside U.S. & Canada)
Workouts, goals & modes:	Quick Start, Manual, Cardio, Fat Burn, Heart Rate Hill™, Heart Rate Interval™, Extreme Heart Rate™ Random, Hill, Time-Based Goal, Time in Zone Goal, Custom Workouts, My Workouts, Life Fitness FitTest, Cool Down Mode, Speed Training, Around the World, Cascades, Foothills, Interval, Kilimanjaro, EZ Resistance, Sport Training, Total Body, Lower Body
Resistance levels:	25
Heart rate monitoring systems:	Patented Lifepulse™ digital contact heart rate and Polar® telemetry-compatible heart rate monitoring system
Console displays:	Elapsed time, total distance, total calories burned, calories burned per hour, heart rate, target heart rate, Watts, METS, workout profile, resistance level, speed
Ports (2):	Type RJ45, interchangeable
Mobile Device charging:	5Vdc @ 500mA
Headphone jack:	3.5mm Stereo, 150mW max

Physical Dimensions	
Length	81.75 in. / 207.65 cm
Width	28 in. / 71.12 cm
Height	65 in. / 165 cm (with console)
Weight (base)	232 lbs. / 105.24 kg      236 lbs. / 107.05 kg (with console)

Shipping Dimensions (without console)	
Length	80 in. / 203 cm
Width	28 in. / 71 cm
Height	47.5 in. / 121 cm
Domestic Weight	296 lbs. / 134.27 kg

# 8 Warranty

Model	Lifetime	3 Years	1 Year
<b>CSX Cross-Trainer</b>	<ul style="list-style-type: none"> <li>Frame</li> </ul>	<ul style="list-style-type: none"> <li>Electrical &amp; Mechanical Parts</li> </ul>	<ul style="list-style-type: none"> <li>Labor</li> </ul>

**WHAT IS COVERED:**

This Life Fitness consumer product ("Product") is warranted to be free of all defects in material and workmanship.

**WHO IS COVERED:**

The original purchaser or any person receiving a newly purchased Product as a gift from the original purchaser. Warranty will be voided on subsequent transfers.

**HOW LONG IS IT COVERED:**

Residential: All electrical and mechanical components and labor are covered, after the date of purchase, as listed on the chart above.

Non-Residential: Warranty void (this Product is intended for residential use only).

**WHO PAYS SHIPPING & INSURANCE FOR SERVICE:**

If the Product or any warranted part must be returned to a service facility for repairs, Life Fitness will pay all shipping and insurance charges during the warranty period (within the United States only). The purchaser is responsible for shipping and insurance charges after the warranty has expired.

**WHAT WE WILL DO TO CORRECT COVERED DEFECTS:**

We will ship to you any new or rebuilt replacement part or component, or, at our option, replace the Product. Such replacement parts are warranted for the remaining portion of the original warranty period.

**WHAT IS NOT COVERED:**

Any failures or damage caused by unauthorized service, misuse, accident, negligence, improper assembly or installation, debris resulting from any construction activities in the Product's environment, rust or corrosion as a result of the Product's location, alterations or modifications without our written authorization or by failure on your part to use, operate and maintain the Product as set out in your User Manual ("Manual"). All terms of this warranty are void if this Product is moved beyond the continental borders of the United States of America (excluding Alaska, Hawaii and Canada) and are then subject to the terms provided by that country's local authorized Life Fitness Representative.

**WHAT YOU MUST DO:**

Retain proof of purchase. Use, operate and maintain the Product as specified in the Manual; notify the place of purchase of any defect within 10 days after discovery of the defect; if instructed, return any defective part for replacement or, if necessary, the entire Product for repair. Life Fitness reserves the right to decide whether or not a product is to be returned for repair.

**USER MANUAL:**

It is VERY IMPORTANT THAT YOU READ THE MANUAL before operating the Product. Remember to perform the periodic maintenance requirements specified in the Manual to assure proper operation and your continued satisfaction.

**PRODUCT REGISTRATION:**

Register online at [www.lifefitness.com/home/product-registration.html](http://www.lifefitness.com/home/product-registration.html). Our receipt assures that your name, address and date of purchase are on file as a registered owner of the Product. Being a registered owner assures coverage in the event you lose your proof of purchase. Please retain your proof of purchase, such as your bill of sale or receipt.

**HOW TO GET PARTS & SERVICE:**

Refer to page one of this manual for your local service contact information. Reference your name, address and the serial number of your Product (consoles and frames have separate serial numbers). They will tell you how to get a replacement part, or, if necessary, arrange for service where your Product is located.

**EXCLUSIVE WARRANTY:**

THIS LIMITED WARRANTY IS IN LIEU OF ALL OTHER WARRANTIES OF ANY KIND EITHER EXPRESSED OR IMPLIED, INCLUDING BUT NOT LIMITED TO THE IMPLIED WARRANTIES OF MERCHANTABILITY AND FITNESS FOR A PARTICULAR PURPOSE, AND ALL OTHER OBLIGATIONS OR LIABILITIES ON OUR PART. We neither assume nor authorize any person to assure for us any other obligation or liability concerning the sale of this Product. Under no circumstances shall we be liable under this warranty, or otherwise, of any damage to any person or property, including any lost profits or lost savings, for any special, indirect, secondary, incidental or consequential damages of any nature arising out of the use of or inability to use this Product. Some states do not allow the exclusion or limitation of implied warranties or of liability for incidental or consequential damages, so the above limitations or exclusions may not apply to you. Warranty coverages and terms may differ outside the United States. Please contact the Life Fitness office servicing your country (contact information found at the front of this manual) or visit the applicable local Life Fitness website to receive the specific warranty information for your country.

**CHANGES IN WARRANTY NOT AUTHORIZED:**

No one is authorized to change, modify or extend the terms of this limited warranty.

**EFFECT OF U.S. STATE LAWS:**

This warranty gives you specific legal rights and you may have other rights which vary from state to state and country by country.